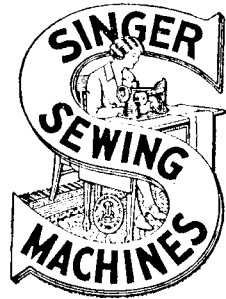


**SINGER**  
**61W52, W72, W84, W154**

# LIST OF PARTS



## MACHINES

Nos. 61w52, 61w72, 61w84  
and 61w154

THE SINGER MANUFACTURING COMPANY

## INDEX

|                                | PAGE |
|--------------------------------|------|
| ACCESSORIES .....              | 35   |
| BINDERS .....                  | 43   |
| BOBBIN WINDER .....            | 34   |
| CORD COVERING ATTACHMENT ..... | 48   |
| CORDERS .....                  | 46   |
| FEED DOGS .....                | 35   |
| FOLDERS .....                  | 49   |
| HEMMERS .....                  | 51   |
| KNEE LUTTER PARTS .....        | 32   |
| MACHINE No. 61w52 .....        | 15   |
| "    "    61w72 .....          | 15   |
| "    "    61w84 .....          | 22   |
| "    "    61w154 .....         | 30   |
| NUMERICAL LIST OF PARTS .....  | 65   |
| PLATELTER .....                | 54   |
| PRESSER FEET .....             | 36   |
| RIBBON REELS .....             | 60   |
| RUFFLER .....                  | 59   |
| THROAT PLATES .....            | 40   |
| WOOD BASE .....                | 60   |

Digitized by Google  
From the Library of  
William Needle Corp.

# Instructions for Ordering

In ordering from this list, use **ONLY** the **PART** number in the **FIRST** column.

The number stamped on a Sewing Machine Part is the number of the Single Part only, except when the part includes Set Screws, Clamping Screws, Studs and Rollers Spun on, Small Wires riveted, or Parts soldered together, etc., which it is necessary to furnish in combination.

Every combination of parts sent out has its specific number which, although not stamped on Parts (except in above cases) must be used when ordering the combination.

Each number always indicates the **SAME PART** in whatever list it appears, or for whatever Machine.

The letters after some of the numbers indicate the style of finish only, as follows:

- A. Hardened, Polished and Plated.
- B. Polished and Plated.
- C. Hardened only.
- D. Polished only.
- E. Soft, not polished.
- F. Hardened and Polished.
- H. Blued.

These letters **MUST BE USED** when they appear in the list and **AFTER** the number, as in the list.

**In this series**

- 200001 to 201500 are Screw Numbers.
- 201501 to 201800 are Nut Numbers.
- 201801 to 202000 are Roller Numbers.
- 202001 and upward are numbers of Machine Parts.

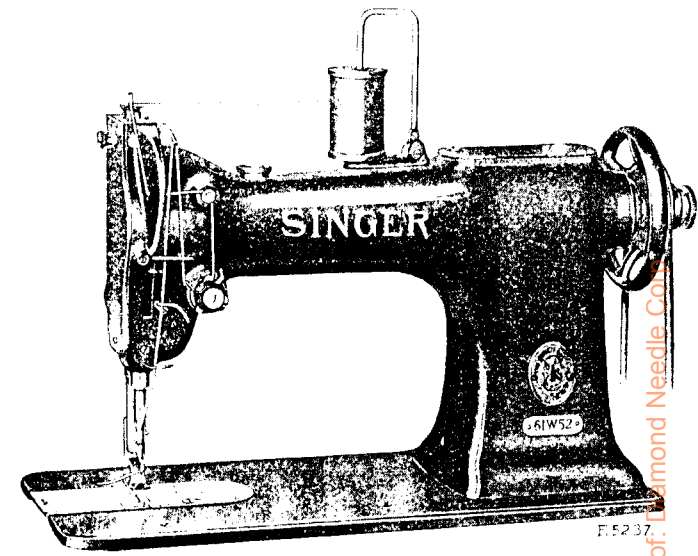
The figures in the second column refer only to the plate in which the illustration of the part is shown and are **NOT TO BE USED** in ordering.

Two or more numbers over a cut indicate that the difference between such parts is not visible in an illustration.

Parts marked with an asterisk (\*) are furnished only when repairs are made at the factory.

## LIST OF PARTS COMPLETE

FOR



### MACHINE No. 61w52

For Shirts, Corsets, Underwear, Shirt Waists, Flannels, Etc.

| No.     | Plate | Name                            |
|---------|-------|---------------------------------|
| *207079 |       | Arm .....                       |
| 202247  | 10667 | " Cap .....                     |
| 200278H | 10244 | " " Screw .....                 |
| 202248  | 10244 | " " Washer .....                |
| 204235  | 13375 | " Position Pin (2) .....        |
| 200010E | 10245 | " Screw (3) .....               |
| 202005  | 10245 | " " Washer (3) .....            |
| 202249  | 13351 | " Shaft with 200357E and 203100 |
| 202243  | 13351 | " " Bushing (back) with         |
|         |       | 202244 .....                    |
| 207080  | 13376 | Arm Shaft Bushing (front) with  |
|         |       | 202244 .....                    |
| 200502B | 10246 | Arm Shaft Bushing (front) Oil   |
|         |       | Packing Thumb Screw .....       |
| 202244  | -     | Arm Shaft Bushing Oil Packing   |
|         |       | (wick) .....                    |

From the library of: **Edmond Needle Co.**

Parts for Machine No. 61w52

| No.     | Plate | Name   |
|---------|-------|--|
| 200338c | 10244 | Arm Shaft Bushing Set Screw (2)  |
| 202530  | 13351 | " " Connection Belt .....  |
| 202252  | 10244 | " " " " Pulley<br>with 200327c, 200602c and two<br>202253 .....  |
| 200602c | 10244 | Arm Shaft Connection Belt Pulley<br>Position Screw .....   |
| 200327c | 10244 | Arm Shaft Connection Belt Pulley<br>Set Screw .....  |
| 202253  | 10244 | Arm Shaft Connection Belt Pulley<br>Spring Flange .....  |
| 203100  | —     | Arm Shaft Oil Packing (wick) ...   |
| 200357E | 10244 | " " " " Stop Screw...  |
| 202255  | 13351 | Balance Wheel (belt groove 2 $\frac{1}{2}$ in.<br>diam.) with 200328c and 200335c                          |
| 200328c | 10244 | Balance Wheel Position Screw ...   |
| 200335c | 10244 | " " Set Screw .....  |
| *207081 | —     | Bed .....  |
| 207082  | 13376 | " Plate (back) .....   |
| 200577H | 10245 | " " " Screw (2) .....  |
| 207083  | 13376 | " Slide (front) .....  |
| 202265  | 11671 | Bobbin .....   |
| *202806 | —     | " Case .....   |
| 202267  | 11671 | " " Latch .....  |
| *202056 | —     | " " Pin .....  |
| 202269  | 11671 | " " Plunger .....  |
| 202270  | 11671 | " " Spring .....   |
| 202716  | 11671 | " " Tension Spring .....   |
| 200984c | 11671 | " " " " Regulating<br>Screw .....  |
| 200594c | 11671 | Bobbin Case Tension Spring Screw   |
| 202533  | 11671 | Bobbin Case complete, Nos. 200594c,<br>200984c, 202056, 202267, 202269,<br>202270, 202716 and 202806 ..... |
| 200459D | 13375 | Cloth Guide Thumb Screw .....  |
| 202274  | 10667 | Face Plate .....   |
| 202135  | 10245 | " " Position Pin .....   |
| 200462b | 10245 | " " Thumb Screw .....  |
| 202275  | 10667 | Feed Bar .....   |
| 200641c | 10246 | " " Hinge Screw (driving)...   |
| 201522E | 10246 | " " " " Nut .....  |
| 202276  | 10245 | " " Slide Block .....  |
| 202298  | 10245 | " " " " Crank with<br>200038c .....  |
| 203124  | —     | Feed Bar Slide Block Crank 202298<br>with 200205E, 201518E and 202276                                      |
| 200038c | 10245 | Feed Bar Slide Block Crank Pinch<br>Screw .....  |

Parts for Machine No. 61w52

| No.     | Plate | Name   |
|---------|-------|--|
| 200205E | 10245 | Feed Bar Slide Block Hinge Screw   |
| 201518E | 10245 | " " " " " " "  |
|         |       | Nut .....  |
| 202282  | 10913 | Feed Dog .....   |
| 200106E | 10245 | " " Screw (2) .....  |
| 202297  | 10667 | " Driving Connection with<br>200054E and 202277 .....  |
| 202298  | 10245 | Feed Driving Connection Crank<br>with 200038c .....  |
| 200038c | 10245 | Feed Driving Connection Crank<br>Pinch Screw .....   |
| 200545c | 10245 | Feed Driving Connection Hinge<br>Screw .....   |
| 201518E | 10245 | Feed Driving Connection Hinge<br>Screw Nut .....   |
| 202277  | —     | Feed Driving Connection Oil Pack-<br>ing (wick) .....  |
| 200054E | 10246 | Feed Driving Connection Pinch<br>Screw .....   |
| 202300  | 10246 | Feed Driving Eccentric Regulating<br>Bracket .....   |
| 203131  | —     | Feed Driving Eccentric Regulating<br>Bracket 202300 with 202252, two<br>each 201014c and 201525E ..... |
| 201014c | 10245 | Feed Driving Eccentric Regulating<br>Bracket Hinge Screw .....   |
| 201525E | 10245 | Feed Driving Eccentric Regulating<br>Bracket Hinge Screw Nut .....                                     |
| 202301  | 10246 | Feed Driving Eccentric Regulating<br>Bracket Plunger .....   |
| 202595  | 10246 | Feed Driving Eccentric Regulating<br>Bracket Plunger Spring .....                                      |
| 200607c | 10246 | Feed Driving Eccentric Regulating<br>Bracket Plunger Spring Stop<br>Screw .....                        |
| 201014c | 10245 | Feed Driving Eccentric Regulating<br>Bracket Stop Screw .....  |
| 201525E | 10245 | Feed Driving Eccentric Regulating<br>Bracket Stop Screw Nut .....                                      |
| 200429c | 10246 | Feed Driving Eccentric Regulating<br>Screw .....   |
| 200383c | 10246 | Feed Driving Eccentric Regulating<br>Screw Check Screw .....   |
| 202303  | 13377 | Feed Driving Rock Shaft .....  |
| 206860  | —     | " " " " 202303<br>with 200641c, 201522E and 202275   |
| 203121  | —     | Feed Driving Rock Shaft 206860<br>with 202282 and two 200106E ...                                      |

| No.     | Plate | Name   |
|---------|-------|--|
| 202305  | 10245 | Feed Driving Rock Shaft Center (2)   |
| 200043c | 10246 | " " " " " Set  |
|         |       | Screw (2) .....  |
| 202306  | 10667 | Feed Lifting Connection with<br>200054e and 202277 .....                                       |
| 202307  | 10246 | Feed Lifting Connection Eccentric<br>with 200382c and 200437c .....                            |
| 200437c | 10246 | Feed Lifting Connection Eccentric<br>Position Screw .....                                      |
| 200382c | 10359 | Feed Lifting Connection Eccentric<br>Set Screw .....   |
| 200545c | 10245 | Feed Lifting Connection Hinge<br>Screw .....   |
| 201518e | 10245 | Feed Lifting Connection Hinge<br>Screw Nut .....   |
| 202277  | ----- | Feed Lifting Connection Oil Pack-<br>ing (wick) .....  |
| 200054e | 10246 | Feed Lifting Connection Pinch<br>Screw .....   |
| 202308  | 13377 | Feed Lifting Rock Shaft .....  |
| 202305  | 10245 | " " " " " Center (2)   |
| 200043c | 10246 | " " " " " " Set  |
|         |       | Screw (2) .....  |
| 202310  | 13376 | Feed Regulating Spindle with<br>202311, 202443 and 202619 .....                                |
| *202311 | ----- | Feed Regulating Spindle Head ....  |
| 202443  | 10244 | " " " " " Pin  |
| 202619  | 13375 | " " " " " Posi-<br>tion Pin .....  |
| *244010 | ----- | Hook (sewing) .....  |
| 244011  | 13377 | " 244010 with 200145c, 200596e,<br>200614c, 202320, 203101, 206775,<br>206852 and 244014 ..... |
| 244012  | ----- | Hook and Bobbin Case complete,<br>Nos. 202533 and 244011 .....                                 |
| 244013  | 13375 | Hook Counter Balance with 200444c  |
| 200444c | 13375 | " " " " " Position Screw   |
| 206852  | 13375 | " " " " " " Gib .....  |
| 200614c | 11671 | " " " " " " Hinge Screw .....  |
| 200596e | 11671 | " " " " " " Screw .....  |
| 203101  | ----- | " " " " " " Oil Wick .....   |
| *202320 | ----- | " " " " " " Shaft, 11½ in. long .....  |
| 202321  | 10245 | " " " " " " Bushing (back) .....   |
| 200346c | 10245 | " " " " " " " Set Screw  |
| 202322  | 10245 | " " " " " " (front) .....  |
| 200346c | 10245 | " " " " " " " Set Screw  |
| 202323  | 10244 | " " " " " " Connection Belt Pulley<br>with 202324 and two 201018c ....                         |
| 201018c | 13375 | Hook Shaft Connection Belt Pulley<br>Set Screw .....   |

| No.     | Plate | Name   |
|---------|-------|--|
| 202324  | 10244 | Hook Shaft Connection Belt Pulley<br>Spring Flange .....                     |
| 202260  | ----- | Hook Shaft Oil Packing (wick) (2)  |
| 206775  | 11671 | " " " " " Pin .....  |
| 244014  | 13375 | " " " " " Washer .....   |
| 200145c | 11671 | " " " " " Screw .....  |
| 237837  | 13377 | Knee Lifter Connection Lever ....  |
| 244035  | ----- | " " " " " " 237837<br>with 202447, 244034 and two<br>200262n .....           |
| 200262n | 10248 | Knee Lifter Connection Lever<br>Hinge Screw .....                            |
| 202417  | 13376 | Knee Lifter Connection Lever Lift-<br>ing Rod with 202302 .....              |
| 202302  | 10248 | Knee Lifter Connection Lever Lift-<br>ing Rod Cotter Pin .....               |
| 244034  | 13377 | Knee Lifter Lifting Lever .....  |
| 200262n | 10248 | " " " " " " Hinge<br>Screw .....   |
| 202326  | 10248 | Needle Bar with 200141e .....  |
| 202327  | 10248 | " " " " " Bushing .....  |
| 203123  | ----- | " " " " " 202327 with 202326   |
| 200352c | 10248 | " " " " " Set Screw ....   |
| 202331  | 10248 | " " " " " Connecting Link ....   |
| 236073  | 13375 | " " " " " " Oil<br>Guard .....   |
| 200161b | 10247 | Needle Bar Connecting Link Oil<br>Guard Screw .....                          |
| 202333  | 10248 | Needle Bar Connecting Link Stud<br>with 202254 .....                         |
| 202254  | ----- | Needle Bar Connecting Link Stud<br>Oil Packing (wick) .....                  |
| 200374c | 13375 | Needle Bar Connecting Link Stud<br>Set Screw .....                           |
| *206891 | ----- | Needle Bar Connecting Stud .....   |
| 202329  | 10248 | " " " " " " 206891<br>with 200086c and 202330 .....                          |
| 202330  | ----- | Needle Bar Connecting Stud Oil<br>Packing (wick) .....                       |
| 200086c | 10248 | Needle Bar Connecting Stud Pinch<br>Screw .....                              |
| 202328  | 13376 | Needle Bar Crank with 200335c,<br>200428c, 202333 and two 200374c            |
| 203117  | ----- | Needle Bar Crank 202328 with<br>202329, 202331 and 202398 to<br>202400 ..... |
| 203172  | 10248 | Needle Bar Crank Friction Washer   |
| 200428c | 10248 | " " " " " Position Screw ..  |
| 200335c | 10244 | " " " " " Set Screw .....  |
| 200141e | 10248 | " " " " " Set Screw .....  |

| No.     | Plate | Name   |
|---------|-------|--|
| 244033  | ---   | Presser Bar (hollow) .....   |
| 202335  | 10667 | " " 244033 with 200074r...   |
| 207072  | 13375 | " " Bushing .....  |
| 200352c | 10248 | " " " Set Screw ....   |
| 202339  | 13375 | " " Lifter .....   |
| 200653c | 13375 | " " " Hinge Screw ...  |
| 244004  | 13375 | " " Lifting Releasing Lev-<br>er Bracket .....                     |
| 200260D | 13375 | Presser Bar Lifting Releasing Lev-<br>er Bracket Guide Screw ..... |
| 206608  | 13375 | Presser Bar Lifting Releasing Lev-<br>er Bracket Spring .....      |
| 202337  | 13375 | Presser Bar Position Guide .....                                   |
| 202338  | 13375 | " " " " Lever<br>with 200086r .....                                |
| 200086r | 10248 | Presser Bar Position Guide Lever<br>Pinch Screw .....              |
| 200352c | 10248 | Presser Bar Position Guide Set<br>Screw .....                      |
| 202343  | 13378 | Presser Bar Spring (light) .....                                   |
| 202346  | 13378 | " " " Stop Rod .....   |
| 200492B | 13378 | " " Thumb Screw (pres-<br>sure regulating) .....                   |
| 200475B | 13378 | Presser Bar Thumb Screw Thumb<br>Set Screw .....                   |
| 202355  | 13378 | Presser Bar Thumb Screw Thumb<br>Set Screw Packing (brass) .....   |
| 202418  | 10929 | Presser Foot .....   |
| 200074r | 13378 | " " Screw .....  |
| 202068  | 12153 | Spool Holder Base .....  |
| 200575H | 13378 | " " " Screw .....  |
| 204296  | 12153 | " " Wire .....   |
| 200079H | 13378 | " " " Hinge Screw ...  |
| 204297  | 12153 | Spool Holder complete, Nos.<br>200079H, 202068 and 204296 .....    |
| 202397  | 13378 | Take-up (auxiliary) .....  |
| 200842E | 13378 | " " Screw .....  |
| 202398  | 10247 | " Lever .....  |
| 202399  | 10247 | " " Driving Stud with<br>202277 .....                              |
| 202277  | ----  | Take-up Lever Driving Stud Oil<br>Packing (wick) .....             |
| 202400  | 10247 | Take-up Lever Hinge Stud with<br>202423 .....                      |
| 202423  | ----  | Take-up Lever Hinge Stud Oil<br>Packing (wick) .....               |
| 200383c | 10246 | Take-up Lever Hinge Stud Set<br>Screw .....                        |

| No.     | Plate | Name   |
|---------|-------|--|
| 202401  | 10247 | Take-up Lever Oiling Felt .....  |
| 200132E | 10247 | " " " " Screw ..   |
| 244007  | 10247 | Tension Disc (back) .....  |
| 244008  | 10247 | " " (front) .....  |
| 202404  | 10247 | " Release Plunger .....  |
| 202405  | 10247 | " " Washer .....   |
| 202407  | 10881 | " Spring .....   |
| 200625r | 10247 | " Stud with 204925 .....   |
| 200061c | 13378 | " Set Screw .....  |
| 204925  | 13378 | " Washer .....   |
| 201572B | 10881 | " Thumb Nut .....  |
| 202409  | 10252 | Tension complete, Nos. 200625r,<br>201572B, 202405, 202407, 202410,<br>244007 and 244008 .....         |
| 202410  | 10252 | Thread Controller Spring .....   |
| 202411  | 10252 | " " " Stop ....  |
| 200132E | 10247 | " " " " Screw ..   |
| 202413  | 10252 | " Guide .....  |
| 202414  | 10252 | " " .....  |
| 202415  | 10252 | " " .....  |
| 202417  | 10252 | " " .....  |
| 200582H | 10252 | " " Screw .....  |
| 200355H | 10252 | " " Set Screw .....  |
| 200368H | 13378 | " " " " .....  |
| 202091  | 10252 | " Retainer Sleeve .....  |
| 202092  | 10252 | " " Spring .....   |
| 204058  | 10252 | " " Stud .....   |
| 200368H | 13378 | " " " Set Screw ....   |
| 204059  | ----  | Thread Retainer complete, Nos.<br>202091, 202092 and 204058 .....                                      |
| 202818  | 13354 | Throat Plate, 50 needle hole, for<br>needle sizes 14 and 15, with<br>202534, 202619 and two 200583H... |
| 202534  | 10390 | Throat Plate Bobbin Case Stop  |
| 202619  | 13375 | " " " " "  |
|         |       | Position Pin .....   |
| 200583H | 13378 | Throat Plate Bobbin Case Stop<br>Screw .....   |
| 200577H | 10245 | Throat Plate Screw (2) .....   |

**LIST OF PARTS COMPLETE**  
**FOR**  
**MACHINE No. 61w72**

For Tuck Marking. Has Tuck Marker Operated  
 by the Feed Lifting Rock Shaft

| No.     | Plate | Name   |
|---------|-------|--|
| *207079 | —     | Arm .....  |
| 202247  | 10667 | " Cap .....  |
| 200278H | 10244 | " " Screw .....  |
| 202248  | 10244 | " " Washer .....   |
| 204235  | 13375 | " Position Pin .....   |
| 200010E | 10245 | " Screw .....  |
| 202005  | 10245 | " Washer .....   |
| 202249  | 13351 | " Shaft with 200357E and 203100                                      |
| 202243  | 13351 | " " Bushing (back) with<br>202244 .....                              |
| 200502B | 10246 | Arm Shaft Bushing Oil Packing<br>Thumb Screw .....                   |
| 202244  | —     | Arm Shaft Bushing Oil Packing<br>(wick) .....                        |
| 200338C | 10244 | Arm Shaft Bushing Set Screw ...                                      |
| 202530  | 13351 | " " Connection Belt .....  |
| 202252  | 10244 | " " " " Pulley<br>with 200327C, 200602E and two<br>202253 .....      |
| 200602E | 10244 | Arm Shaft Connection Belt Pulley<br>Position Screw .....             |
| 200327C | 10244 | Arm Shaft Connection Belt Pulley<br>Set Screw .....                  |
| 202253  | 10244 | Arm Shaft Connection Belt Pulley<br>Spring Flange .....              |
| 203100  | —     | Arm Shaft Oil Packing (wick) ...                                     |
| 200357E | 10244 | " " " " Stop Screw...  |
| 202255  | 13351 | Balance Wheel (belt groove 2¼ in.<br>diam.) with 200328C and 200335C |
| 200328C | 10244 | Balance Wheel Position Screw ...                                     |
| 200335C | 10244 | " " Set Screw .....  |
| *207081 | —     | Bed .....  |
| 207083  | 13376 | " Slide (front) .....  |
| 202265  | 11671 | Bobbin .....   |
| *202806 | —     | " Case .....   |
| 202267  | 11671 | " " Latch .....  |
| *202056 | —     | " " " Pin .....  |
| 202269  | 11671 | " " " Plunger .....  |

| No.     | Plate | Name   |
|---------|-------|--|
| 202270  | 11671 | Bobbin Case Latch Spring .....   |
| 202716  | 11671 | " " Tension Spring .....   |
| 200984C | 11671 | " " " " Regulat-<br>ing Screw .....  |
| 200594C | 11671 | Bobbin Case Tension Spring Screw   |
| 202533  | 11671 | Bobbin Case complete, Nos. 200594C,<br>200984C, 202056, 202267, 202269,<br>202270, 202716 and 202806 ..... |
| 200459D | 13375 | Cloth Guide Thumb Screw .....  |
| 202274  | 10667 | Face Plate .....   |
| 202135  | 10245 | " " Position Pin .....   |
| 200462B | 10245 | " " Thumb Screw .....  |
| 202275  | 10667 | Feed Bar .....   |
| 200641C | 10246 | " " Hinge Screw (driving)..  |
| 201522E | 10246 | " " " " Nut .....  |
| 202276  | 10245 | " " Slide Block .....  |
| 202298  | 10245 | " " " " Crank with<br>200038C .....  |
| 203124  | —     | Feed Bar Slide Block Crank 202298<br>with 200205E, 201518E and 202276                                      |
| 200038C | 10245 | Feed Bar Slide Block Crank Pinch<br>Screw .....  |
| 200205E | 10245 | Feed Bar Slide Block Hinge Screw   |
| 201518E | 10245 | " " " " " " "<br>Nut .....   |
| 202294  | 10912 | Feed Dog .....   |
| 200106E | 10245 | " " Screw (2) .....  |
| 202297  | 10667 | " Driving Connection with<br>200054E and 202277 .....  |
| 202298  | 10245 | Feed Driving Connection Crank<br>with 200038C .....  |
| 200038C | 10245 | Feed Driving Connection Crank<br>Pinch Screw .....   |
| 200545C | 10245 | Feed Driving Connection Hinge<br>Screw .....   |
| 201518E | 10245 | Feed Driving Connection Hinge<br>Screw Nut .....   |
| 202277  | —     | Feed Driving Connection Oil Pack-<br>ing (wick) .....  |
| 200054E | 10246 | Feed Driving Connection Pinch<br>Screw .....   |
| 202300  | 10246 | Feed Driving Eccentric Regulating<br>Bracket .....   |
| 203134  | —     | Feed Driving Eccentric Regulating<br>Bracket 202300 with 202252, two<br>each 201014C and 201525E .....     |
| 201014C | 10245 | Feed Driving Eccentric Regulating<br>Bracket Hinge Screw .....   |
| 201525E | 10245 | Feed Driving Eccentric Regulating<br>Bracket Hinge Screw Nut .....   |

| No.     | Plate | Name  |
|---------|-------|---|
| 202301  | 10246 | Feed Driving Eccentric Regulating Bracket Plunger .....                   |
| 202595  | 10246 | Feed Driving Eccentric Regulating Bracket Plunger Spring .....            |
| 200607c | 10246 | Feed Driving Eccentric Regulating Bracket Plunger Spring Stop Screw ..... |
| 201014c | 10245 | Feed Driving Eccentric Regulating Bracket Stop Screw .....                |
| 201525E | 10245 | Feed Driving Eccentric Regulating Bracket Stop Screw Nut .....            |
| 200429c | 10246 | Feed Driving Eccentric Regulating Screw .....                             |
| 200383c | 10246 | Feed Driving Eccentric Regulating Screw Check Screw .....                 |
| 202303  | 10365 | Feed Driving Rock Shaft .....   |
| 206860  | —     | " " " " 202303 with 200641c, 201522E and 202275                           |
| 203121  | —     | Feed Driving Rock Shaft 206860 with 202282 and two 200106E ..             |
| 202305c | 10245 | Feed Driving Rock Shaft Center (2)  |
| 200043c | 10246 | " " " " " Set Screw (2) .....   |
| 202306  | 10667 | Feed Lifting Connection with 200054E and 202277 .....                     |
| 202307  | 10246 | Feed Lifting Connection Eccentric with 200382c and 200437c .....          |
| 200437c | 10246 | Feed Lifting Connection Eccentric Position Screw .....                    |
| 200382c | 10359 | Feed Lifting Connection Eccentric Set Screw .....                         |
| 200545c | 10245 | Feed Lifting Connection Hinge Screw .....                                 |
| 201518E | 10245 | Feed Lifting Connection Hinge Screw Nut .....                             |
| 202277  | —     | Feed Lifting Connection Oil Packing (wick) .....                          |
| 200054E | 10246 | Feed Lifting Connection Pinch Screw .....                                 |
| 202308  | 13377 | Feed Lifting Rock Shaft .....   |
| 202305c | 10245 | " " " " Center (2)  |
| 200043c | 10246 | " " " " " Set Screw (2) .....   |
| 202310  | 13376 | Feed Regulating Spindle with 202311, 202443 and 202619 .....              |
| *202311 | —     | Feed Regulating Spindle Head ...  |
| 202443  | 10244 | " " " " Pin   |
| 202619  | 13375 | " " " " Position Pin .....  |

| No.     | Plate | Name   |
|---------|-------|--|
| *244010 | —     | Hook (sewing) .....  |
| 244011  | 13377 | " 244010 with 200145c, 200596E, 200614c, 202320, 203101, 206775, 206852 and 244014 ..... |
| 244012  | —     | Hook and Bobbin Case complete, Nos. 202533 and 244011 .....                              |
| 244013  | 13375 | Hook Counter Balance with 200444c  |
| 200444c | 13375 | " " " Position Screw   |
| 206852  | 13375 | " Gib .....  |
| 200614c | 11671 | " " Hinge Screw .....  |
| 200596E | 11671 | " " Screw .....  |
| 203101  | —     | " Oil Wick .....   |
| *202320 | —     | " Shaft, 11 <sup>1</sup> / <sub>2</sub> in. long .....                                   |
| 202321  | 10245 | " " Bushing (back) .....   |
| 200346c | 10245 | " " " " Set Screw  |
| 202322  | 10245 | " " " (front) .....  |
| 200346c | 10245 | " " " " Set Screw ..   |
| 202323  | 10244 | " " Connection Belt Pulley with 202324 and two 201018c ..                                |
| 201018c | 13375 | Hook Shaft Connection Belt Pulley Set Screw .....  |
| 202324  | 10244 | Hook Shaft Connection Belt Pulley Spring Flange .....                                    |
| 202260  | —     | Hook Shaft Oil Packing (wick) (2)  |
| 206775  | 11671 | " " Pin .....  |
| 244014  | 13375 | " Washer .....   |
| 200145c | 11671 | " " Screw .....  |
| 237837  | 13377 | Knee Lifter Connection Lever   |
| 244035  | —     | " " " "  |
|         |       | 237837 with 202447, 244034 and two 200262n .....   |
| 200262n | 10248 | Knee Lifter Connection Lever Hinge Screw .....   |
| 202447  | 13376 | Knee Lifter Connection Lever Lifting Rod with 202302 .....                               |
| 202302  | 10248 | Knee Lifter Connection Lever Lifting Rod Cotter Pin .....                                |
| 244034  | 13377 | Knee Lifter Lifting Lever  |
| 200262n | 10248 | " " " " Hinge Screw .....  |
| 202326  | 10248 | Needle Bar with 200141E .....  |
| 202327  | 10248 | " " Bushing .....  |
| 203123  | —     | " " " 202327 with 202326 .....   |
| 200352c | 10248 | Needle Bar Bushing Set Screw ...   |
| 202331  | 10248 | " " Connecting Link .....  |
| 236073  | 13375 | " " " " Oil Guard .....  |



| No.     | Plate | Name   |
|---------|-------|--|
| 209161b | 10247 | Needle Bar Connecting Link Oil Guard Screw .....                       |
| 202333  | 10248 | Needle Bar Connecting Link Stud with 202254 .....                      |
| 202254  | ---   | Needle Bar Connecting Link Stud Oil Packing (wick) .....               |
| 200374c | 13375 | Needle Bar Connecting Link Stud Set Screw .....                        |
| *206891 | ---   | Needle Bar Connecting Stud .....                                       |
| 202329  | 10248 | " " " " 206891 with 200086c and 202330 .....                           |
| 202330  | ---   | Needle Bar Connecting Stud Oil Packing (wick) .....                    |
| 200086c | 10248 | Needle Bar Connecting Stud Pinch Screw .....                           |
| 202328  | 13376 | Needle Bar Crank with 200335c, 200428c, 202333 and two 200374c         |
| 203117  | ---   | Needle Bar Crank 202328 with 202329, 202331 and 202398 to 202400 ..... |
| 203172  | 10248 | Needle Bar Crank Friction Washer                                       |
| 200428c | 10248 | " " " Position Screw   |
| 200335c | 10244 | " " " Set Screw .....  |
| 200141F | 10248 | " Set Screw .....  |
| 244033  | ---   | Presser Bar (hollow) .....   |
| 202335  | 10667 | " " 244033 with 200074F  |
| 207072  | 13375 | " " Bushing .....  |
| 200352c | 10248 | " " " Set Screw .....  |
| 202339  | 13375 | " " Lifter .....   |
| 200653c | 13375 | " " " Hinge Screw .....  |
| 244004  | 13375 | " " Lifting Releasing Lever Bracket .....                              |
| 200260b | 13375 | Presser Bar Lifting Releasing Lever Bracket Guide Screw .....          |
| 206608  | 13375 | Presser Bar Lifting Releasing Lever Bracket Spring .....               |
| 202337  | 13375 | Presser Bar Position Guide .....                                       |
| 202338  | 13375 | " " " " Lever with 200086F .....                                       |
| 200086F | 10248 | Presser Bar Position Guide Lever Pinch Screw .....                     |
| 200352c | 10248 | Presser Bar Position Guide Set Screw .....                             |
| 202343  | 13378 | Presser Bar Spring (high) .....  |
| 202346  | 13378 | " " " Stop Rod .....   |
| 200492B | 13378 | " " Thumb Screw (pressure regulating) .....                            |
| 200475B | 13378 | Presser Bar Thumb Screw Thumb Set Screw .....                          |

| No.     | Plate | Name   |
|---------|-------|--|
| 202355  | 13378 | Presser Bar Thumb Screw Thumb Set Screw Packing (brass) .....                            |
| 203177  | 13380 | Presser Foot .....   |
| 200074F | 13378 | " " Screw .....  |
| 202068  | 12153 | Spool Holder Base .....  |
| 200575H | 13378 | " " " Screw .....  |
| 204296  | 12153 | " " Wire .....   |
| 200079H | 13378 | " " " Hinge Screw .....  |
| 204297  | 12153 | Spool Holder complete, Nos. 200079H, 202068 and 204296 .....                             |
| 202397  | 13378 | Take-up (auxiliary) .....  |
| 200842E | 13378 | " " Screw .....  |
| 202398  | 10247 | " Lever .....  |
| 202399  | 10247 | " " Driving Stud with 202277 .....   |
| 202277  | ---   | Take-up Lever Driving Stud Oil Packing (wick) .....                                      |
| 202400  | 10247 | Take-up Lever Hinge Stud with 202423 .....   |
| 202423  | ---   | Take-up Lever Hinge Stud Oil Packing (wick) .....  |
| 200383c | 10246 | Take-up Lever Hinge Stud Set Screw .....   |
| 202401  | 10247 | Take-up Lever Oiling Felt .....  |
| 200432E | 10247 | " " " " Screw  |
| 244007  | 10247 | Tension Disc (back) .....  |
| 244008  | 10247 | " " (front) .....  |
| 202404  | 10247 | " Release Plunger .....  |
| 202405  | 10247 | " " Washer .....   |
| 202407  | 10881 | " Spring .....   |
| 200625F | 10247 | " Stud with 204925 .....   |
| 200061c | 13378 | " " Set Screw .....  |
| 204925  | 13378 | " " Washer .....   |
| 201572b | 10881 | " Thumb Nut .....  |
| 202409  | 10252 | Tension complete, Nos. 200625F, 201572b, 202405, 202407, 202410, 244007 and 244008 ..... |
| 202410  | 10252 | Thread Controller Spring .....   |
| 202411  | 10252 | " " " Stop .....   |
| 200432E | 10247 | " " " " Screw  |
| 202413  | 10252 | " Guide .....  |
| 202414  | 10252 | " " .....  |
| 202415  | 10252 | " " .....  |
| 202417  | 10252 | " " .....  |
| 200582H | 10252 | " " Screw .....  |
| 200355H | 10252 | " Set Screw .....  |
| 200368H | 13378 | " " " " .....  |
| 202091  | 10252 | " Retainer Sleeve .....  |
| 202092  | 10252 | " " Spring .....   |

| No.     | Plate | Name   |
|---------|-------|--|
| 204058  | 10252 | Thread Retainer Stud .....   |
| 200368H | 13378 | " " " Set Screw ..   |
| 204059  | ---   | Thread Retainer complete, Nos.<br>202091, 202092 and 204058 .....                                      |
| 202830  | 13380 | Throat Plate, 53 needle hole, for<br>needle sizes 12 and 13, with<br>202534, 202619 and two 200583H .. |
| 202534  | 10390 | Throat Plate Bobbin Case Stop ..   |
| 202619  | 13375 | " " " " " Po-<br>sition Pin .....  |
| 200583H | 13378 | Throat Plate Bobbin Case Stop<br>Screw .....   |
| 200577H | 10245 | Throat Plate Screw (2) .....   |
| 225935  | 10381 | Tuck Marker .....  |
| 244027  | 13379 | " " Guide .....  |
| 244028  | ---   | " " " 244027 with<br>200179H and 244029 .....  |
| 200469B | 13378 | Tuck Marker Guide Thumb Screw  |
| 244029  | 13379 | " " " Tuck Smooth-<br>ing Spring .....   |
| 200179H | 10361 | Tuck Marker Guide Tuck Smooth-<br>ing Spring Screw .....   |
| 200125F | 10381 | Tuck Marker Set Screw .....  |
| 225936  | 13379 | " " Shaft with 200125F ...   |
| 225937  | 13379 | " " " Bracket with two<br>200579E .....  |
| 244030  | 13379 | Tuck Marker Shaft Bracket Base<br>Plate .....  |
| 200567H | ---   | Tuck Marker Shaft Bracket Base<br>Plate Screw (2) .....  |
| 200579E | 10359 | Tuck Marker Shaft Bracket Screw  |
| 225945  | ---   | " " " Driving Crank<br>with 201813 .....   |
| 225896  | ----  | Tuck Marker Shaft Driving Crank<br>Cap .....   |
| 200047C | 10381 | Tuck Marker Shaft Driving Crank<br>Pinch Screw .....   |
| 201829  | 10381 | Tuck Marker Shaft Driving Crank<br>Roller .....  |
| 201813  | 13378 | Tuck Marker Shaft Driving Crank<br>Roller 201829 with 200274E .....                                    |
| 200274E | 10381 | Tuck Marker Shaft Driving Crank<br>Roller Screw Stud .....   |
| 225939  | 13379 | Tuck Marker Shaft Driving Crank<br>complete, Nos. 200047C, 225896<br>and 225945 .....                  |
| 225941  | 13379 | Tuck Marker Shaft Rock Lever   |
| 225997  | ---   | " " " " " "<br>225941 with 225942 .....  |

| No.     | Plate | Name  |
|---------|-------|---|
| 200852B | 10381 | Tuck Marker Shaft Rock Lever<br>Pinch Screw .....   |
| 225942  | 10381 | Tuck Marker Shaft Rock Lever<br>Pinch Screw Handle with 200852B   |
| 225943  | 10381 | Tuck Marker Shaft Stop Collar with<br>200481B .....   |
| 200481B | 10381 | Tuck Marker Shaft Stop Collar<br>Thumb Screw .....  |
| 225931  | 10381 | Tuck Marker Tuck Creaser .....  |
| *225932 | ---   | " " " " " Plate   |
| 225707  | 13379 | " " " " " "<br>225932 with 202115, 225931, 225933,<br>225934, two each 200142E and<br>200172H .....         |
| 202115  | 13379 | Tuck Marker Tuck Creaser Plate<br>Spring .....  |
| 200142E | 10346 | Tuck Marker Tuck Creaser Plate<br>Spring Screw .....  |
| 225933  | 10381 | Tuck Marker Tuck Creaser Slide  |
| 225934  | 10381 | " " " " " "<br>Spring .....   |
| 200172H | 10381 | Tuck Marker Tuck Creaser Slide<br>Spring Screw .....  |
| 244031  | ---   | Tuck Marker with 200469B, 225707,<br>225935 to 225937, 225939, 225997,<br>244028, 244030 and two 225943 ... |
| 244032  | ----  | Tuck Marker complete, Nos. 202294,<br>202830, 203177, 203187, 206992 and<br>244031 .....                    |

**LIST OF PARTS COMPLETE**  
**FOR**  
**MACHINE No. 61w84**

**HAS MECHANICAL OPENER**

For Shirts, Corsets, Underwear, Shirt Waists,  
 Flannels, Etc

| No.     | Plate | Name  |
|---------|-------|---|
| *207079 | ----  | Arm .....   |
| 202247  | 10667 | " Cap .....   |
| 200278H | 10244 | " " Screw .....   |
| 202248  | 10244 | " " " Washer .....  |
| 204235  | 13375 | " Position Pin (2) .....  |
| 200010E | 10245 | " Screw (3) .....   |
| 202005  | 10245 | " " Washer (3) .....  |
| 202249  | 13351 | " Shaft with 200357E and 203100 .....                                   |
| 202243  | 13351 | " " Bushing (back) with 202244 .....                                    |
| 207080  | 13376 | Arm Shaft Bushing (front) with 202244 .....                             |
| 200502B | 10246 | Arm Shaft Bushing (front) Oil Packing Thumb Screw .....                 |
| 202244  | ----  | Arm Shaft Bushing Oil Packing (wick) .....                              |
| 20033Sc | 10244 | Arm Shaft Bushing Set Screw (2) .....                                   |
| 202530  | 13351 | " " Connection Belt .....   |
| 202252  | 10244 | " " " " Pulley with 200327c, 200602e and two 202253 .....               |
| 200602E | 10244 | Arm Shaft Connection Belt Pulley Position Screw .....                   |
| 200327c | 10244 | Arm Shaft Connection Belt Pulley Set Screw .....                        |
| 202253  | 10244 | Arm Shaft Connection Belt Pulley Spring Flange .....                    |
| 203100  | ----  | Arm Shaft Oil Packing (wick) .....                                      |
| 200357E | 10244 | " " " " Stop Screw .....  |
| 202255  | 13351 | Balance Wheel (belt groove 2½ in. diam.) with 200328c and 200335c ..... |
| 200328c | 10244 | Balance Wheel Position Screw .....                                      |
| 200335c | 10244 | " " Set Screw .....   |

| No.     | Plate | Name   |
|---------|-------|--|
| *207081 |       | Bed .....  |
| 207082  | 13376 | " Plate (back) .....   |
| 200577H | 10245 | " " " Screw (2) .....  |
| 207083  | 13376 | " Slide (front) .....  |
| 202265  | 11671 | Bobbin .....   |
| 207057  | 13363 | " Case Base .....  |
| 206733  | 13378 | " " Cap with 200592c, 201016F and 206738 .....   |
| 206734  | 13363 | Bobbin Case Cap complete, Nos. 200964E, 206733, 206736 and 210736 .....                                |
| 206735  | 13363 | Bobbin Case Latch .....  |
| 206736  |       | " " " 206735 with 206731 and 206737 .....  |
| 206731  | 13363 | Bobbin Case Latch Fulcrum Pin .....  |
| 206737  | 13363 | " " " Lever .....  |
| 210736  | 13363 | " " " Spring .....   |
| 200964E | 13363 | " " " Stop Screw .....   |
| 206738  | 13363 | " " Tension Spring .....   |
| 201016F | 13363 | " " " " Regulat- ing Screw .....   |
| 200592c | 13378 | Bobbin Case Tension Spring Screw .....   |
| 207058  | 13363 | Bobbin Case complete, Nos. 206734 and 207057 .....   |
| 202500  | 13378 | Bobbin Case Lever .....  |
| 202501  | 13378 | " " " Bushing .....  |
| 200333c | 13378 | " " " " Set Screw .....  |
| 244018  | 13378 | " " " Driving Eccen- tric with 200380c and 200444c .....   |
| 244019  |       | Bobbin Case Lever Driving Eccen- tric 244018 with 200583H and 206761 .....                             |
| 206728  | 13363 | Bobbin Case Lever Driving Eccen- tric Connection with 244009 .....                                     |
| 244020  |       | Bobbin Case Lever Driving Eccen- tric Connection 206728 with 201194c, 201524c, 206758 and 244019 ..... |
| 206730  | 13363 | Bobbin Case Lever Driving Eccen- tric Connection Lever with 200086c .....                              |
| 201194c | 13363 | Bobbin Case Lever Driving Eccen- tric Connection Lever Hinge Screw Stud .....                          |
| 201524c | 13378 | Bobbin Case Lever Driving Eccen- tric Connection Lever Hinge Screw Stud Nut .....                      |
| 206758  | ---   | Bobbin Case Lever Driving Eccen- tric Connection Lever Oil Wick..                                      |

| No.     | Plate | Name   |
|---------|-------|--|
| 200086c | 10248 | Bobbin Case Lever Driving Eccentric Connection Lever Pinch Screw .....                     |
| 244009  | —     | Bobbin Case Lever Driving Eccentric Connection Oil Packing (wick) .....                    |
| 200380c | 13378 | Bobbin Case Lever Driving Eccentric Set Screw .....  |
| 200444c | 13375 | Bobbin Case Lever Driving Eccentric Spot Screw .....                                       |
| 206761  | 13363 | Bobbin Case Lever Driving Eccentric Washer .....   |
| 200583H | 13378 | Bobbin Case Lever Driving Eccentric Washer Screw .....                                     |
| 244021  | —     | Bobbin Case Outfit complete, Nos. 200333c, 202500, 202501, 206730, 207058 and 244020 ..... |
| 200459D | 13375 | Cloth Guide Thumb Screw .....  |
| 202274  | 10667 | Face Plate .....   |
| 202135  | 10245 | " " Position Pin .....   |
| 200462B | 10245 | " " Thumb Screw .....  |
| 202275  | 10667 | Feed Bar .....   |
| 200641c | 10246 | " " Hinge Screw (driving) .....  |
| 201522E | 10240 | " " " " Nut .....  |
| 202276  | 10245 | " " Slide Block .....  |
| 202298  | 10245 | " " " " Crank with 200038c .....   |
| 203124  | —     | Feed Bar Slide Block Crank 202298 with 200205E, 201518E and 202276 .....                   |
| 200038c | 10245 | Feed Bar Slide Block Crank Pinch Screw .....   |
| 200205E | 10245 | Feed Bar Slide Block Hinge Screw .....   |
| 201518E | 10245 | " " " " " " " " Nut .....  |
| 202282  | 10913 | Feed Dog .....   |
| 200106E | 10245 | " " Screw (2) .....  |
| 202297  | 10667 | " Driving Connection with 200054E and 202277 .....   |
| 202298  | 10245 | Feed Driving Connection Crank with 200038c .....   |
| 200038c | 10245 | Feed Driving Connection Crank Pinch Screw .....  |
| 200545c | 10245 | Feed Driving Connection Hinge Screw .....  |
| 201518E | 10245 | Feed Driving Connection Hinge Screw Nut .....  |
| 202277  | —     | Feed Driving Connection Oil Packing (wick) .....   |
| 200054E | 10246 | Feed Driving Connection Pinch Screw .....  |

| No.     | Plate | Name   |
|---------|-------|--|
| 202300  | 10246 | Feed Driving Eccentric Regulating Bracket .....  |
| 203134  | —     | Feed Driving Eccentric Regulating Bracket 202300 with 202252, two each 201014c and 201525E ..... |
| 201014c | 10245 | Feed Driving Eccentric Regulating Bracket Hinge Screw .....                                      |
| 201525E | 10245 | Feed Driving Eccentric Regulating Bracket Hinge Screw Nut .....                                  |
| 202301  | 10246 | Feed Driving Eccentric Regulating Bracket Plunger .....  |
| 202595  | 10246 | Feed Driving Eccentric Regulating Bracket Plunger Spring .....                                   |
| 200607c | 10246 | Feed Driving Eccentric Regulating Bracket Plunger Spring Stop Screw .....                        |
| 201014c | 10245 | Feed Driving Eccentric Regulating Bracket Stop Screw .....                                       |
| 201525E | 10245 | Feed Driving Eccentric Regulating Bracket Stop Screw Nut .....                                   |
| 200429c | 10246 | Feed Driving Eccentric Regulating Screw .....  |
| 200383c | 10246 | Feed Driving Eccentric Regulating Screw Check Screw .....  |
| 202303  | 13377 | Feed Driving Rock Shaft .....  |
| 206860  | —     | " " " " 202303 with 200641c, 201522E and 202275 .....  |
| 203121  | —     | Feed Driving Rock Shaft 206860 with 202282 and two 200106c .....                                 |
| 202305  | 10245 | Feed Driving Rock Shaft Center (2) .....   |
| 200043c | 10246 | " " " " " " Set Screw (2) .....  |
| 202306  | 10667 | Feed Lifting Connection with 200054E and 202277 .....  |
| 202307  | 10246 | Feed Lifting Connection Eccentric with 200382c and 200437c .....                                 |
| 200437c | 10246 | Feed Lifting Connection Eccentric Position Screw .....   |
| 200382c | 10359 | Feed Lifting Connection Eccentric Set Screw .....  |
| 200545c | 10245 | Feed Lifting Connection Hinge Screw .....  |
| 201518E | 10245 | Feed Lifting Connection Hinge Screw Nut .....  |
| 202277  | —     | Feed Lifting Connection Oil Packing (wick) .....   |
| 200054E | 10246 | Feed Lifting Connection Pinch Screw .....  |

| No.     | Plate | Name   |
|---------|-------|--|
| 202308  | 13377 | Feed Lifting Rock Shaft .....  |
| 202305  | 10245 | " " " " Center (2)   |
| 200043c | 10246 | " " " " Set Screw (2) .....  |
| 202310  | 13376 | Feed Regulating Spindle with 202311, 202443 and 202619 .....                             |
| *202311 | ----  | Feed Regulating Spindle Head ...   |
| 202443  | 10244 | " " " " Pin  |
| 202619  | 13375 | " " " " Position Pin .....   |
| *244010 | ----  | Hook (sewing) .....  |
| 244011  | 13377 | " 244010 with 200145c, 200596c, 200614c, 202320, 203101, 206775, 206852 and 244014 ..... |
| 244022  | ----  | Hook and Bobbin Case complete, Nos. 207058 and 244011 .....                              |
| 206852  | 13375 | Hook Gib .....   |
| 200614c | 11671 | " " Hinge Screw .....  |
| 200596c | 11671 | " " Screw .....  |
| 203101  | ----  | " Oil Wick .....   |
| *202320 | ----  | " Shaft, 11 $\frac{1}{2}$ in. long .....   |
| 202321  | 10245 | " " Bushing (back) .....   |
| 200346c | 10245 | " " " " Set Screw  |
| 202322  | 10245 | " " " (front) .....  |
| 200346c | 10245 | " " " " Set Screw  |
| 202323  | 10244 | " " Connection Belt Pulley with 202324 and two 201018c ...                               |
| 201018c | 13375 | Hook Shaft Connection Belt Pulley Set Screw .....  |
| 202324  | 10244 | Hook Shaft Connection Belt Pulley Spring Flange .....                                    |
| 202260  | ----  | Hook Shaft Oil Packing (wick) (2)  |
| 206775  | 11671 | " " Pin .....  |
| 244014  | 13375 | " Washer .....   |
| 200145c | 11671 | " " Screw .....  |
| 237837  | 13377 | Knee Lifter Connection Lever .....   |
| 244035  | ----  | " " " " 237837 with 202447, 244034 and two 200262n .....                                 |
| 200262n | 10248 | Knee Lifter Connection Lever Hinge Screw .....   |
| 202447  | 13376 | Knee Lifter Connection Lever Lifting Rod with 202302 .....                               |
| 202302  | 10248 | Knee Lifter Connection Lever Lifting Rod Cotter Pin .....                                |
| 244034  | 13377 | Knee Lifter Lifting Lever .....  |
| 200262n | 10248 | " " " " Hinge Screw .....  |

| No.     | Plate | Name   |
|---------|-------|--|
| 202326  | 10248 | Needle Bar with 200141F .....  |
| 202327  | 10248 | " " Bushing .....  |
| 203123  | ----  | " " " " 202327 with 202326 .....                                       |
| 200352c | 10248 | Needle Bar Bushing Set Screw ...                                       |
| 202331  | 10248 | " " Connecting Link .....  |
| 236073  | 13375 | " " " " Oil Guard .....  |
| 200161n | 10247 | Needle Bar Connecting Link Oil Guard Screw .....                       |
| 202333  | 10248 | Needle Bar Connecting Link Stud with 202254 .....                      |
| 202254  | ----  | Needle Bar Connecting Link Stud Oil Packing (wick) .....               |
| 200374c | 13375 | Needle Bar Connecting Link Stud Set Screw .....                        |
| *206891 | ----  | Needle Bar Connecting Stud .....                                       |
| 202329  | 10248 | " " " " 206891 with 200086c and 202330 .....                           |
| 202330  | ----  | Needle Bar Connecting Stud Oil Packing (wick) .....                    |
| 200086c | 10248 | Needle Bar Connecting Stud Pinch Screw .....                           |
| 202328  | 13376 | Needle Bar Crank with 200335c, 200428c, 202333 and two 200374c         |
| 203117  | ----  | Needle Bar Crank 202328 with 202329, 202331 and 202398 to 202400 ..... |
| 203172  | 10248 | Needle Bar Crank Friction Washer                                       |
| 200428c | 10248 | " " " Position Screw ..  |
| 200335c | 10244 | " " " Set Screw .....  |
| 200141F | 10248 | " Set Screw .....  |
| 244033  | ----  | Presser Bar (hollow) .....   |
| 202335  | 10667 | " " 244033 with 200074F ..   |
| 207072  | 13375 | " " Bushing .....  |
| 200352c | 10248 | " " " Set Screw .....  |
| 202339  | 13375 | " " Lifter .....   |
| 200653c | 13375 | " " " Hinge Screw ....   |
| 244004  | 13375 | " " Lifting Releasing Lever Bracket .....                              |
| 200260n | 13375 | Presser Bar Lifting Releasing Lever Bracket Guide Screw .....          |
| 206608  | 13375 | Presser Bar Lifting Releasing Lever Bracket Spring .....               |
| 202337  | 13375 | Presser Bar Position Guide .....                                       |
| 202338  | 13375 | " " " " Lever with 200086F .....                                       |
| 200086F | 10248 | Presser Bar Position Guide Lever Pinch Screw .....                     |

| No.     | Plate | Name   |
|---------|-------|--|
| 200352C | 10248 | Presser Bar Position Guide Set<br>Screw .....  |
| 202343  | 13378 | Presser Bar Spring (light) .....   |
| 202346  | 13378 | " " " Stop Rod .....   |
| 200492B | 13378 | " " Thumb Screw (pres-<br>sure regulating) .....   |
| 200475B | 13378 | Presser Bar Thumb Screw Thumb<br>Set Screw .....   |
| 202355  | 13378 | Presser Bar Thumb Screw Thumb<br>Set Screw Packing (brass) .....                               |
| 202418  | 10929 | Presser Foot .....   |
| 200074F | 13378 | " " Screw .....  |
| 202068  | 12153 | Spool Holder Base .....  |
| 200575H | 13378 | " " " Screw .....  |
| 204296  | 12153 | " " Wire .....   |
| 200079H | 13378 | " " " Hinge Screw ....   |
| 204297  | 12153 | Spool Holder complete, Nos.<br>200079H, 202068 and 204296 .....                                |
| 202397  | 13378 | Take-up (auxiliary) .....  |
| 200842E | 13378 | " " Screw .....  |
| 202398  | 10247 | " Lever .....  |
| 202399  | 10247 | " " Driving Stud with<br>202277 .....  |
| 202277  | ---   | Take-up Lever Driving Stud Oil<br>Packing (wick) .....   |
| 202400  | 10247 | Take-up Lever Hinge Stud with<br>202423 .....  |
| 202423  | ---   | Take-up Lever Hinge Stud Oil<br>Packing (wick) .....   |
| 200383C | 10246 | Take-up Lever Hinge Stud Set<br>Screw .....  |
| 202401  | 10247 | Take-up Lever Oiling Felt .....  |
| 200132E | 10247 | " " " " Screw ..   |
| 244007  | 10247 | Tension Disc (back) .....  |
| 244008  | 10247 | " " (front) .....  |
| 202404  | 10247 | " Release Plunger .....  |
| 202405  | 10247 | " " Washer .....   |
| 202407  | 10881 | " Spring .....   |
| 200625F | 10247 | " Stud with 204925 .....   |
| 200061C | 13378 | " " Set Screw .....  |
| 204925  | 13378 | " " Washer .....   |
| 201572B | 10881 | " Thumb Nut .....  |
| 202409  | 10252 | Tension complete, Nos. 200625F,<br>201572B, 202405, 202407, 202410,<br>244007 and 244008 ..... |
| 202410  | 10252 | Thread Controller Spring .....   |
| 202411  | 10252 | " " " Stop .....   |
| 200132E | 10247 | " " " " Screw  |

| No.     | Plate | Name   |
|---------|-------|--|
| 202413  | 10252 | Thread Guide .....   |
| 202414  | 10252 | " " " .....  |
| 202415  | 10252 | " " " .....  |
| 202417  | 10252 | " " " .....  |
| 200582H | 10252 | " " Screw .....  |
| 200355H | 10252 | " " Set Screw .....  |
| 200368H | 13378 | " " " " .....  |
| 202091  | 10252 | " Retainer Sleeve .....  |
| 202092  | 10252 | " " Spring .....   |
| 204058  | 10252 | " " Stud .....   |
| 200368H | 13378 | " " " Set Screw .....  |
| 204059  | -     | Thread Retainer complete, Nos.<br>202091, 202092 and 204058 .....                                      |
| 202818  | 13354 | Throat Plate, 50 needle hole, for<br>needle sizes 14 and 15, with<br>202534, 202619 and two 200583H .. |
| 202534  | 10390 | Throat Plate Bobbin Case Stop ...  |
| 202619  | 13375 | " " " " " Po-<br>sition Pin .....  |
| 200583H | 13378 | Throat Plate Bobbin Case Stop<br>Screw .....   |
| 200577H | 10245 | Throat Plate Screw (2) .....   |

## MACHINE No. 61w154

For Shirts, Corsets, Underwear, Shirt Waists,  
Flannels, Etc

Same as Machine No. 61w84 with the following  
exceptions:

| No.     | Plate | Name   |
|---------|-------|--|
| *207084 | ---   | Arm, in place of 207079 .....  |
| 202250  | 13365 | " Shaft with 200357e and 203100,<br>in place of 202249 .....   |
| *207085 | ---   | Bed, in place of 207081 .....  |
| 207086  | 13376 | " Slide (front), in place of 207083  |
| 202304  | 13365 | Feed Driving Rock Shaft, in place<br>of 202303 .....   |
| 203122  | ---   | Feed Driving Rock Shaft 202304<br>with 200641c, 201522e and 202275,<br>in place of 206860 .....                          |
| 202654  | 13365 | Feed Lifting Rock Shaft, in place<br>of 202308 .....   |
| 244023  | 13377 | Hook 244010 with 200145c, 200596e,<br>200614c, 202319, 203101, 206775,<br>206852 and 244014, in place of<br>244011 ..... |
| 244024  | ---   | Hook and Bobbin Case complete,<br>Nos. 207058 and 244023, in place<br>of 244022 .....                                    |
| *202319 | ---   | Hook Shaft, 13 <sup>3</sup> / <sub>4</sub> in. long, in place<br>of 203320 .....   |
| 244037  | ---   | Knee Lifter Connection Lever<br>237837 with 202447, 244036 and<br>two 200262n, in place of 244035...                     |
| 244036  | 13377 | Knee Lifter Lifting Lever, in place<br>of 244034 .....   |

## ACCESSORIES

FOR MACHINES NOS. 61w52 and 61w84

| No.     | Plate | Name  |
|---------|-------|---|
| 200157b | 13380 | Attachment Screw .....  |
| 202265  | 11671 | Bobbin (5) .....  |
| *225482 | ---   | " Case Screw Driver Blade ...   |
| *225483 | ---   | " " " " Handle ..   |
| 225497  | 12153 | Bobbin Case Screw Driver com-<br>plete, Nos. 225482 and 225483 ...                            |
| 231337  | 13380 | Cloth Guide .....   |
| 12361   | 13380 | Machine Hinge Connection (2) ...  |
| 135 x 1 | ---   | Needles, three each, sizes 12 and 14  |
| 228212  | ---   | Drip Pan (short) with four 1 in.<br>wire nails .....  |
| 41400   | 12153 | Machine Rest Pin .....  |
| 120342  | 12153 | Oiler with 120343 .....   |
| 120343  | 12153 | " Spout, 3 <sup>1</sup> / <sub>2</sub> in. long .....   |
| *225484 | ---   | Screw Driver Blade .....  |
| *225485 | ---   | " " Handle .....  |
| 225498  | 12153 | Screw Driver complete (7 <sup>1</sup> / <sub>2</sub> in.<br>long), Nos. 225484 and 225485 ... |
| 225554  | 12153 | Wrench (steel) .....  |

### BOBBIN WINDER

Swing Automatic, Right Hand

|         |       |                                  |
|---------|-------|----------------------------------|
| 225453  | 10884 | Frame with 202277 and 225438 ... |
| 225454  | 10884 | " Hinge Pin .....                |
| 202277  | ---   | " Oil Packing (wick) .....       |
| 225438  | 10884 | " " Well Cap .....               |
| 225455  | 10884 | " Spring .....                   |
| 225456  | 10884 | " " Flunger .....                |
| 202473  | 10885 | Pulley with 200380c .....        |
| 200380c | 13378 | " Set Screw .....                |
| 225381  | 10884 | Spindle .....                    |
| 225444  | 10884 | Stop Latch .....                 |
| 200056e | 10884 | " " Screw .....                  |
| 225458  | 10884 | " " Thumb Lever .....            |
| 225459  | 10884 | " " " " Hinge Stud               |
| 225459  | 10884 | " " " " Joint Stud               |
| 202478  | 10884 | " " Trip Lever .....             |
| 200299n | 10884 | " " " " Hinge Screw              |

| No.     | Plate | Name  |
|---------|-------|---|
| 225461  | 10881 | Tension Bracket with 201499B . . . .  |
| 200082D | 10881 | " " Screw . . . . .   |
| 228026  | 10884 | " " Washer . . . . .  |
| 2102    | 10881 | " Disc . . . . .  |
| 202407  | 10881 | " Spring . . . . .  |
| 201499B | 10881 | " Stud . . . . .  |
| 201572B | 10881 | " " Thumb Nut . . . . .   |
| 225462  | 10881 | Bobbin Winder Tension Bracket complete, Nos. 201572B, 202407, 225461 and two 2102 . . . . .   |
| 225433  | 10885 | Bobbin Winder and Tension Bracket Base . . . . .  |
| 225382  | 10885 | Universal Bobbin Winder complete, Nos. 200056E, 200082D, 200299B, 202473, 202478, 225381, 225433, 225444, 225453 to 225456, 225458, 225462, 228026, two each 225459 and wood screws $\frac{3}{4}$ in., No. 12, R.H.B. . . . . |

## KNEE LIFTER PARTS

|         |       |  |
|---------|-------|--|
| 2763    | 14171 | Rock Shaft . . . . .   |
| 7539    | 14171 | " " Hanger (back) with two wood screws 1 in., No. 10 . . . . .         |
| 20093   | 14171 | Rock Shaft Hanger (front) with two wood screws 1 in., No. 10 . . . . . |
| 2765    | 14171 | Rock Shaft Knee Arm . . . . .  |
| 2768    | —     | " " " " 2765 with 2766 and 2767 . . . . .                              |
| 2766    | 14171 | Rock Shaft Knee Arm Hub with 356c . . . . .                            |
| 356c    | 14171 | Rock Shaft Knee Arm Hub Set Screw . . . . .                            |
| 2767    | 14171 | Rock Shaft Knee Plate with 356c . . . . .                              |
| 356c    | 14171 | " " " " Set Screw . . . . .  |
| 228238  | 14171 | " " Lifting Lever with 356c . . . . .                                  |
| 228239  | —     | " " " " 228238 with 8073, 204225, 228240 and 228241 . . . . .          |
| 228240  | 14171 | Rock Shaft Lifting Lever Rod (3 in. long) . . . . .                    |
| 200529c | 14171 | Rock Shaft Lifting Lever Rod Set Screw . . . . .                       |
| 228241  | 14171 | Rock Shaft Lifting Lever Rod Swivel with 200529c . . . . .             |
| 204225  | 14171 | Rock Shaft Lifting Lever Rod Swivel Spring . . . . .                   |

| No.    | Plate | Name   |
|--------|-------|--|
| 8073   | 14171 | Rock Shaft Lifting Lever Rod Swivel Spring Plunger . . . . .                                 |
| 356c   | 14171 | Rock Shaft Lifting Lever Set Screw . . . . .   |
| 2770   | 14171 | " " Stop Dog with 356c . . . . .   |
| 356c   | 14171 | " " " " Set Screw . . . . .  |
| 228242 | 14171 | Knee Lifter Rock Shaft complete, Nos. 2763, 2768, 7539, 20093, 228239 and two 2770 . . . . . |

(Other Knee Lifter Parts are listed with parts of machine head)

## FOR MACHINE No. 61w72

Same as for No. 61w52 with the following exceptions:

|        |       |                        |
|--------|-------|------------------------|
| 203187 | 13380 | Presser Foot . . . . . |
| 206992 | 13380 | " " . . . . .          |

## FOR MACHINE No. 61w154

Same as for No. 61w52 with the following exceptions:

|        |   |  |
|--------|---|--|
| 228213 | — | Drip Pan (long) with four 1 in. wire nails, in place of 228212 . . . . . |
|--------|---|--|

## KNEE LIFTER PARTS

|        |       |   |
|--------|-------|---|
| 2763   | 14171 | Rock Shaft . . . . .  |
| 7539   | 14171 | " " Hanger (back) with two wood screws 1 in., No. 10 . . . . .            |
| 20093  | 14171 | Rock Shaft Hanger (front) with two wood screws 1 in., No. 10 . . . . .    |
| 228562 | 14407 | Rock Shaft Knee Arm . . . . .   |
| 228563 | —     | Rock Shaft Knee Arm complete, Nos. 1507B, 2766, 2767 and 228562 . . . . . |
| 2766   | 14171 | Rock Shaft Knee Arm Hub with 356c . . . . .                               |
| 356c   | 14171 | Rock Shaft Knee Arm Hub Set Screw . . . . .                               |
| 1507B  | 13380 | Rock Shaft Knee Arm Lock Nut . . . . .                                    |
| 2767   | 14171 | " " " Plate with 356c . . . . .   |
| 228255 | 14407 | " " " " Counter Balance Spring . . . . .                                  |
| 356c   | 14171 | Rock Shaft Knee Plate Set Screw . . . . .                                 |
| 228238 | 14171 | " " Lifting Lever with 356c . . . . .                                     |
| 228239 | —     | " " " " 228238 with 8073, 204225, 228240 and 228241 . . . . .             |



| No.     | Plate | Name  |
|---------|-------|---|
| 228240  | 14171 | Rock Shaft Lifting Lever Rod (3 in. long) .....   |
| 200529c | 14171 | Rock Shaft Lifting Lever Rod Set Screw .....  |
| 228241  | 14171 | Rock Shaft Lifting Lever Rod Swivel with 200529c .....  |
| 204225  | 14171 | Rock Shaft Lifting Lever Rod Swivel Spring .....  |
| 8073    | 14171 | Rock Shaft Lifting Lever Rod Swivel Spring Plunger .....  |
| 356c    | 14171 | Rock Shaft Lifting Lever Set Screw  |
| 2770    | 14171 | " " Stop Dog with 356c ...  |
| 356c    | 14171 | " " " " Set Screw ...   |
| 228243  | 14407 | Knee Lifter Rock Shaft complete, Nos. 2763, 7539, 20093, 228239, 228255, 228563, Form A 1079 and two 2770 ..... |

(Other Knee Lifter Parts are listed with parts of machine head)

## FEED DOGS

| No.    | Plate | Name  |
|--------|-------|---|
| 202278 | 10913 | Feed Dog, for binding, for 202811 and 225996 .....                                  |
| 202281 | 10913 | Feed Dog, for 202815 .....  |
| 202282 | 10913 | " " " general muslin work, for 202818, 202951, 203073, 203113 and 203121 .....      |
| 202283 | 10913 | Feed Dog, for handkerchief hemming knit goods and shoe lining                       |
| 202284 | 10913 | Feed Dog, for binding dress shields, for 202812 .....                               |
| 202287 | 10913 | Feed Dog, for muslin work and gathering, for 202822 .....                           |
| 202289 | 10913 | Feed Dog, for 202817 .....  |
| 202290 | 10912 | " " " special work, for 202824 .....  |
| 202293 | 10912 | Feed Dog, 21 teeth (22 teeth to the inch), for tucking, for 202827 and 244041 ..... |
| 202294 | 10912 | Feed Dog, for tucking, for 202828, 202830 and 244032 .....                          |
| 202295 | 10912 | Feed Dog, for tucking, for 202829..   |
| 202296 | 10912 | " " " " " 202831..  |
| 202970 | 10912 | " " " general muslin work, for 202969 .....   |
| 203071 | 10912 | Feed Dog, for 203056 and 206975 ..  |
| 203072 | 10912 | " " " 203053 .....  |
| 203083 | 10912 | " " " 203063 .....  |
| 203136 | 13354 | " " " 202816 .....  |
| 203173 | 13354 | " " " 226000 .....  |
| 203417 | 13354 | " " " 203111 .....  |
| 207051 | 10915 | " " " handkerchief hemming, knit goods and shoe lining, for 202819 .....            |
| 207052 | 10915 | Feed Dog, for handkerchief hemming, knit goods and shoe lining, for 202819 .....    |
| 207053 | 10915 | Feed Dog, for shirt, collar and cuff work, for 202817 .....                         |
| 207054 | 10915 | Feed Dog, for shirt, collar and cuff work, for 202817 .....                         |
| 207055 | 10915 | Feed Dog, for general muslin work, for 202818, 202951, 203073 and 203113 .....      |

| No.    | Plate | Name   |
|--------|-------|--|
| 207056 | 10915 | Feed Dog, for general muslin work, for 202818, 202951, 203073 and 203113 ..... |
| 207075 | 13380 | Feed Dog, for leather work, for 207076 .....                                   |
| 225977 | 10310 | Feed Dog, for 225622 .....   |
| 230625 | 13354 | " " " 230749, 230751 and 230833 .....  |

## PRESSER FEET

|        |       |   |
|--------|-------|---|
| 26608  | 13355 | Presser Foot (glass) .....  |
| 202354 | 10926 | " " for $\frac{1}{32}$ , $\frac{1}{16}$ and $\frac{1}{8}$ in. stitching margins, for collar and cuff work .....                 |
| 202356 | 10263 | Presser Foot, for binding .....   |
| 202361 | 10926 | " " " " .....   |
| 202368 | 10259 | " " (deep grooved) (grooved to left of needle hole), from 4 to 16 cords to the in., as ordered, for top cording .....           |
| 202369 | 10259 | Presser Foot (deep grooved) (grooved to left of needle hole), from 4 to 16 cords to the in., as ordered, for top cording .....  |
| 202370 | 10259 | Presser Foot (deep grooved) (grooved to right of needle hole), from 4 to 16 cords to the in., as ordered, for top cording ..... |
| 202373 | 13355 | Presser Foot, for gathering .....   |
| 202375 | 10926 | " " " mattress binding .....  |
| 202376 | 10926 | " " " " " " .....   |
| 202390 | 10263 | " " " front steel stitching in corset work .....  |
| 202418 | 10929 | Presser Foot .....  |
| 202529 | 10926 | " " (split), for gathering .....  |
| 203177 | 13380 | " " .....   |
| 203179 | 10926 | " " for $\frac{1}{16}$ in. stitching margin, for collar and cuff work .....   |
| 203187 | 13380 | Presser Foot, for tuck marking or creasing .....  |

| No.    | Plate | Name   |
|--------|-------|--|
| 203198 | 13355 | Presser Foot, for laying tucks .....   |
| 203199 | 13355 | " " " narrow tucks .....   |
| 206528 | 10925 | " " " stitching margins $\frac{1}{32}$ , $\frac{1}{16}$ and $\frac{1}{8}$ inch .....   |
| 206785 | 10929 | Presser Foot .....   |
| 206786 | 10929 | " " (split) .....  |
| 206787 | 13355 | " " for stitching margins from $\frac{1}{32}$ to $\frac{1}{4}$ in., in steps of $\frac{1}{32}$ inch .....                          |
| 206788 | 10929 | Presser Foot .....   |
| 206791 | 10925 | " " for use with English Binder .....  |
| 206792 | 10925 | Presser Foot, for stitching margins from $\frac{1}{16}$ to $\frac{1}{4}$ in., in steps of $\frac{1}{16}$ inch .....                |
| 206794 | 10929 | Presser Foot, for tailoring work .....   |
| 206841 | 13355 | " " " binding .....  |
| 206992 | 13380 | " " " tuck marking or creasing .....   |
| 225508 | 10923 | Presser Foot, for gathering .....  |
| 225621 | 10310 | " " .....  |
| 225690 | 10923 | " " from 4 to 16 cords to the in., as ordered, for top and bottom cording .....  |
| 225702 | 13356 | Presser Foot, for Welts .....  |
| 225723 | 10926 | " " .....  |
| 225792 | 10350 | " " .....  |
| 225798 | 10353 | " " .....  |
| 225862 | 13356 | " " for stitching margins from $\frac{1}{16}$ to $\frac{1}{4}$ in., in steps of $\frac{1}{16}$ in., for collar and cuff work ..... |
| 225949 | 13356 | Presser Foot, for Welts .....  |
| 226029 | 10923 | " " " darning .....  |
| 229597 | 10925 | " " stitching margins from $\frac{1}{4}$ to $\frac{1}{8}$ in., in steps of $\frac{1}{8}$ in., for open bosom shirts .....          |
| 229856 | 10929 | Presser Foot .....   |
| 229857 | 10929 | " " .....  |
| 229858 | 10929 | " " .....  |
| 229880 | 13356 | " " for binding suspenders .....   |
| 230745 | 14650 | " " " cord covering .....  |
| 206842 | 13356 | " " Cleft Holder .....   |
| 206998 | 13356 | Presser Foot Holder with 2005430, for Presser Bar 202335 as a substitute for Compound Presser Bar 202514 .....                     |

| No.     | Plate | Name  |
|---------|-------|---|
| 200543u | 13356 | Presser Foot Screw .....  |
| 202366  | 10926 | " " for stitching margins from $\frac{1}{8}$ to $\frac{1}{4}$ in., in steps of $\frac{1}{16}$ in., with 200175u and 202810 .....  |
| 206790  | 10927 | Presser Foot, for stitching margins from $\frac{1}{8}$ to $\frac{1}{4}$ in., in steps of $\frac{1}{16}$ in., with 200904e and 202809 .....  |
| 229871  | 10925 | Presser Foot (right hand spring guide), stitching margins from $\frac{1}{8}$ to $\frac{1}{4}$ in., in steps of $\frac{1}{16}$ in., with 200175u and 202807. Order margin required ..... |
| 202809  | 10927 | Presser Foot Adjustable Spring Guide .....  |
| 200904e | 13356 | Presser Foot Adjustable Spring Guide Screw .....  |
| 202807  | 10925 | Presser Foot Spring Guide .....   |
| 202810  | 10926 | " " " " .....   |
| 200175u | 10360 | " " " " Screw .....   |
| 203037  | ----- | " " Plate with 231235 to 231237 and six 200175u .....   |
| 202572  | 13356 | Presser Foot Hinge Pin .....  |
| 231235  | ----- | " " Strip Guide with 200488c .....  |
| 231236  | ----- | Presser Foot Strip Guide Bar .....  |
| 231237  | ----- | " " " " " Plate .....   |
| 200175u | 10360 | " " " " " Screw .....   |
| 200488c | 13380 | Presser Foot Strip Guide Thumb Screw .....  |
| 231238  | 13355 | Presser Foot (hinged) (adjustable) complete, for strips $\frac{1}{8}$ to $\frac{1}{4}$ in., Nos. 202572, 202924 and 203037, for stitching shoe facings .....                            |
| 202090  | 13356 | Presser Foot Hinge Pin .....  |
| 203009  | ----- | " " Plate, for 229864 .....   |
| 203010  | ----- | " " " " 229863 .....  |
| 203011  | ----- | " " " " 229867 .....  |
| 203012  | ----- | " " " " 229868 .....  |
| 203024  | ----- | " " " " 229865 .....  |
| 203034  | ----- | " " " " 202372 .....  |
| 203035  | ----- | " " " " 202371 .....  |
| 203322  | ----- | " " " " 203323 .....  |
| 229055  | ----- | " " " " 202351 .....  |
| 202924  | ----- | " " Shank .....   |
| 202351  | 10927 | Presser Foot (hinged) complete, 46 needle hole, Nos. 202090, 202924 and 229055, for knif goods .....  |

| No.    | Plate | Name   |
|--------|-------|--|
| 202371 | 13356 | Presser Foot (hinged) complete, Nos. 202090, 202924 and 203035, for umbrella hemming .....       |
| 202372 | 13352 | Presser Foot (hinged) complete, Nos. 202090, 202924 and 203034, for handkerchief hemming .....   |
| 202323 | 13356 | Presser Foot (hinged) complete, 50 needle hole, Nos. 202090, 202924 and 203322 .....             |
| 229863 | 10927 | Presser Foot (hinged) complete, Nos. 202090, 202924 and 203010, for overalls and tailoring ..... |
| 229864 | 10927 | Presser Foot (hinged) complete, Nos. 202090, 202924 and 203099 .....                             |
| 229865 | 10927 | Presser Foot (hinged) complete, Nos. 202090, 202924 and 203024, for tailoring .....              |
| 229867 | 10927 | Presser Foot (hinged) complete, Nos. 202090, 202924 and 203011, for overalls .....               |
| 229868 | 10927 | Presser Foot (hinged) complete, Nos. 202090, 202924 and 203012 .....                             |

## THROAT PLATES

| No.    | Plate | Name  |
|--------|-------|---|
| 202811 | 13354 | Throat Plate, 50 needle hole, for needle sizes 14 and 15, with 202534, 244026 and two 200582u, for binding corsets and similar work, for 202278 ..... |
| 202812 | 10390 | Throat Plate, 46 needle hole, for needle sizes 16 and 18, with 202534, 202619 and two 200583u, for 202284, 226197, 226215 and 226239 .....            |
| 202815 | 10391 | Throat Plate, 53 needle hole, for needle sizes 12 and 13, with 202534, 202619 and two 200583u, for tucking work, for 202281 .....                     |
| 202816 | 10391 | Throat Plate, 50 needle hole, for needle sizes 14 and 15, with 202534, 202619 and two 200582u, for top cording, for 203136 .....                      |
| 202817 | 10391 | Throat Plate, 60 needle hole, for needle sizes 8 and 9, with 202534, 202619 and two 200583u, for fine shirt work, for 202289, 207053 and 207054 ..... |
| 202818 | 13354 | Throat Plate, 50 needle hole, for needle sizes 14 and 15, with 202534, 202619 and two 200583u, for 202282, 207055 and 207056 ..                       |
| 202819 | 10391 | Throat Plate, 50 needle hole, for needle sizes 14 and 15, with 202534, 202619 and two 200583u, for 202283, 207051 and 207052 ..                       |
| 202822 | 10391 | Throat Plate, 50 needle hole, for needle sizes 14 and 15, with 202534, 202619 and two 200583u, for muslin work and gathering, for 202287 .....        |
| 202824 | 10390 | Throat Plate, 50 needle hole, for needle sizes 14 and 15, with 202534, 202619 and two 200583u, for special work, for 202290 .....                     |
| 202827 | 10390 | Throat Plate, 53 needle hole, for needle sizes 12 and 13, with 202534, 202619 and two 200583u, for 202293 and 244041 .....                            |

| No.    | Plate | Name  |
|--------|-------|---|
| 202828 | 13354 | Throat Plate, 53 needle hole, for needle sizes 12 and 13, with 202534, 202619 and two 200583u, for tucking with Tuck Folder, for 202294 .....               |
| 202829 | 10390 | Throat Plate, 53 needle hole, for needle sizes 12 and 13, with 202534, 202619 and two 200583u, for special tucking, for 202295 ..                           |
| 202830 | 13380 | Throat Plate, 53 needle hole, for needle sizes 12 and 13, with 202534, 202619 and 200583u, for 202294 and 244032 .....                                      |
| 202831 | 10391 | Throat Plate, 50 needle hole, for needle sizes 14 and 15, with 202534, 202619 and two 200583u, for 202296 .....   |
| 202951 | 13357 | Throat Plate, 56 needle hole, for needle sizes 10 and 11, with 202534, 202619 and two 200583u, for 202282, 207055 and 207056 ..                             |
| 202969 | 10917 | Throat Plate, 50 needle hole, for needle sizes 14 and 15, with 202534, 202619 and two 200583u, for fine shirt work, for 202970 ..                           |
| 203053 | 10917 | Throat Plate, 53 needle hole, for needle sizes 12 and 13, with 202534, 202619 and two 200583u, for 203072 .....   |
| 203056 | 10917 | Throat Plate, 50 needle hole, for needle sizes 14 and 15, with 202534, 202619 and two 200583u, for tucking, for 203071 .....                                |
| 203063 | 10917 | Throat Plate, 50 needle hole, for needle sizes 14 and 15, with 202534, 202619 and two 200582u, for special work, for 203083 .....                           |
| 203073 | 10917 | Throat Plate, 46 needle hole, for needle sizes 16 and 18, with 202534, 202619 and two 200583u, for 202282, 207055 and 207056 ..                             |
| 203111 | 13357 | Throat Plate, 50 needle hole, for needle sizes 14 and 15, with 202534, 202619 and two 200583u, for regular cloth work, for 203417                           |
| 203113 | 13357 | Throat Plate, 40 needle hole, for needle sizes 20 and 22, with 202534, 202619 and two 200583u, for general muslin work, for 202282, 207055 and 207056 ..... |

| No.     | Plate | Name   |
|---------|-------|--|
| 206975  | 13357 | Throat Plate, 50 needle hole, for needle sizes 14 and 15, with 202534, 202619 and two 200583u, for 203071 .....                                      |
| 207076  | 13380 | Throat Plate, 50 needle hole, for needle sizes 14 and 15, with 202534, 202619 and two 200583u, for 207975 .....                                      |
| 225622  | 10310 | Throat Plate, 53 needle hole, for needle sizes 12 and 13, with 202534, 202619 and two 200582u, for 225977 .....                                      |
| 226000  | 13357 | Throat Plate, 53 needle hole, for needle sizes 12 and 13, with 202534, 202619 and two 200583u, for top and bottom cording, for 203173 .....          |
| 230749  | 14650 | Throat Plate, 50 needle hole, for needle sizes 14 and 15, with 201566u, 202534 and two 200583u, for 230625 and 230751 .....                          |
| 230833  | 13357 | Throat Plate, 50 needle hole, for needle sizes 14 and 15, with 201566u, 202534 and two 200583u. Used with Cord Covering Attachment, for 230625 ..... |
| 201566u | 13357 | Cord and Strip Folder Thumb Nut, for 230749 and 230833 .....   |
| 200582u | 10252 | Throat Plate Bobbin Case Stop Screw .....  |
| 244026  | 13380 | Throat Plate Bobbin Case Stop Position Pin .....   |

## BINDERS

| No.    | Plate | Name  |
|--------|-------|---|
| 225646 | 10316 | Binder on Shank, for tapes from $\frac{1}{2}$ to 1 in. in steps of $\frac{1}{16}$ inch .....            |
|        |       | Note: State width required, send samples of material to be bound and sufficient tape to test Binder.    |
| 225659 | 10316 | Bias Binder on Shank, for binding from $\frac{1}{2}$ to 1 in., in steps of $\frac{1}{16}$ inch .....    |
|        |       | Note: State width required, send samples of material to be bound and sufficient binding to test Binder. |

### BINDER

#### For Tapes or Folded Strips Without Seams

|        |       |   |
|--------|-------|---|
| 225624 | 11598 | Binder on Shank, for tapes $\frac{3}{8}$ , $\frac{7}{8}$ , $\frac{1}{2}$ , $\frac{3}{4}$ , $\frac{11}{16}$ , $\frac{13}{16}$ , $\frac{1}{2}$ , $\frac{13}{16}$ and 1 inch ..... |
|        |       | Note: State width required, send samples of material to be bound and sufficient tape to test Binder.  |

### BOSTON BINDER

#### For Shoes and Slippers

|        |       |   |
|--------|-------|---|
| 225630 | 10312 | Binder on Shank, for tapes from $\frac{1}{2}$ to 1 in. in steps of $\frac{1}{16}$ inch .....  |
|        |       | Note: State width required, send samples of material to be bound and sufficient tape to test Binder.  |
| 225631 | 10312 | Binder on Shank with Shank extending beyond Binder, for tapes of the following widths: $\frac{3}{8}$ , $\frac{7}{8}$ , $\frac{1}{2}$ , $\frac{3}{4}$ , $\frac{11}{16}$ , $\frac{13}{16}$ , $\frac{1}{2}$ , $\frac{13}{16}$ and 1 inch ..... |
| 202283 | 10913 | Feed Dog .....  |
| 202356 | 10263 | Presser Foot .....  |
| 202819 | 10391 | Throat Plate, 50 needle hole, for needle sizes 14 and 15, with 202534, 202619 and two 200583u..   |

## BINDER

## For Suspender Tabs

| No.    | Plate | Name  |
|--------|-------|---|
| 225633 | 10312 | Binder on Shank, in sizes $\frac{1}{2}$ and $\frac{3}{8}$ inch .....                            |
| 207075 | 13380 | Feed Dog .....  |
| 229880 | 13356 | Presser Foot .....  |
| 207076 | 13380 | Throat Plate, 50 needle hole, for needle sizes 14 and 15, with 202534, 202619 and two 200583u.. |

## BINDER (BIAS)

|        |       |   |
|--------|-------|---|
| 225634 | 10312 | Binder on Shank, for $\frac{1}{2}$ , $\frac{3}{8}$ and $\frac{1}{4}$ inch ..... |
|--------|-------|---|

## BINDER (ADJUSTABLE)

## For Hats

|         |       |  |
|---------|-------|--|
| 225610  | 10309 | Bed .....  |
| 225612  | 10309 | Folder with 225610 .....                                   |
| 225613  | 10309 | " Slide with 200768e .....                                 |
| 200768e | 10309 | " " Adjusting Screw .....                                  |
| 225614  | 10309 | " " " Thumb Nut Guide .....                                |
| 226077  | ---   | " " " " " " .....  |
|         |       | 225614 with 226112 .....                                   |
| 200164b | 10309 | Folder Slide Adjusting Thumb Nut Guide Screw .....         |
| 226112  | 10309 | Folder Slide Adjusting Thumb Nut Sleeve with 225998 .....  |
| 225998  | 10309 | Folder Slide Adjusting Thumb Nut Sleeve Screw Center ..... |
| 225615  | 10309 | Folder Slide Cap .....                                     |
| 200164b | 10309 | " " " Screw .....  |
| 225616  | 10309 | Guide (front) .....  |
| 200893d | 11598 | " " Thumb Screw .....                                      |
| 225618  | 10309 | " (back, lower) .....                                      |
| 225619  | 10309 | " (back, upper) .....                                      |
| 200893d | 11598 | " (back) Thumb Screw .....                                 |
| 225620  | 10309 | Pressure Spring .....                                      |
| 200176d | 11598 | " " Screw .....  |

| No.    | Plate | Name  |
|--------|-------|---|
| 225623 | 10310 | Binder complete, Nos. 200176d, 225612, 225613, 225615, 225616, 225618 to 225620, 226077, two each 200164b and 200893d ..... |

225977 10310 Feed Dog .....

225621 10310 Presser Foot .....

225622 10310 Throat Plate, 53 needle hole, for needle sizes 12 and 13, with 202534, 202619 and two 200582u..

Note: Nos. 225621, 225622 and 225977 should be used with but not included in No. 225623.

## CORDERS

WHEN ORDERING SEND SAMPLES OF CORD

### CORDER

For Top Cording

For 8, 9, 10, 12, 14 or 16 cords to the inch, as ordered

| No.     | Plate | Name  |
|---------|-------|---|
| 225684  | 10322 | Arm with 200340c, 201533e and three 225686 .....  |
| 200340c | 11598 | Arm Adjusting Screw .....   |
| 201533e | 11598 | " " " Nut .....   |
| 225685  | 10322 | " Bracket with 200851B .....  |
| 225687  | 10322 | " " Hinge Pin .....   |
| 200851B | 10322 | " " Locking Thumb Screw.  |
| 200035E | 11598 | " " Screw .....   |
| 225689  | 10322 | " " Clamp Washer ...  |
| 225686  | 10322 | " Cord Guide .....  |
| 225688  | 11599 | Arm and Bracket complete, Nos. 225684, 225685, 225687, 225689 and two 200035E .....             |
| 203136  | 13354 | Feed Dog .....  |
| 202368  | 10259 | Presser Foot (deep grooved) (grooved to left of needle hole) .....                              |
| 202816  | 10391 | Throat Plate, 50 needle hole, for needle sizes 14 and 15, with 202534, 202619 and two 200582H.. |

### CORDER

For Top and Bottom Cording

For 8, 9, 10, 12, 14 or 16 cords to the inch, as ordered

|        |       |   |
|--------|-------|---|
| 225688 | 11599 | Arm and Bracket complete, Nos. 225684, 225685, 225687, 225689 and two 200035E .....             |
| 203173 | 13354 | Feed Dog .....  |
| 225690 | 10923 | Presser Foot .....  |
| 226000 | 13357 | Throat Plate, 53 needle hole, for needle sizes 12 and 13, with 202534, 202619 and two 200583H.. |

## BOW CORDER

For Sunbonnets, etc.

| No.  | Plate | Name  |
|--|-------|---|
| 225693                                       | 10325 | Presser Foot and Bracket .....  |
| Note: When ordering 225693 send sample cord. |       |   |
| 225695                                       | ---   | Presser Foot Bracket Bow, 8 in. long, with 225698 and 231149 ...                    |
| 225698                                       | 10325 | Presser Foot Bracket Bow Cord Tube (order size wanted) .....                        |
| 231149                                       | ---   | Presser Foot Bracket Bow Cord Tube (short) .....                                    |
| 200185D                                      | 10325 | Presser Foot Bracket Bow Screw  |
| 206482                                       | 13356 | " " " " " Washer .....  |
| 225699                                       | 10325 | Corder, 8 in. bow, complete, Nos. 225693, 225695, two each 200185D and 206482 ..... |

## BOW CORDER

For Infants' Caps, Etc.

|        |       |   |
|--------|-------|---|
| 225696 | 10325 | Presser Foot Bracket Bow, 6 in. long, with 225698 and 231149 ...                    |
| 225930 | 10325 | Corder, 6 in. bow, complete, Nos. 225693, 225696, two each 200185D and 206482 ..... |

## BOW CORDER

For Extra Fine Work

|        |       |   |
|--------|-------|---|
| 225697 | ---   | Presser Foot Bracket Bow, 4 in. long, with 225698 and 231149 ...                    |
| 225940 | 10325 | Corder, 4 in. bow, complete, Nos. 225693, 225697, two each 200185D and 206482 ..... |

Note: When ordering 225699, 225630 or 225940 send sample of cord on material to be used.

## CORD COVERING ATTACHMENT

| No.     | Plate | Name   |
|---------|-------|--|
| 230744  | 14650 | Cord Guide and Strip Folder .....  |
| 200137D | 10359 | " " " " " Screw  |
| 201566B | 13357 | " " " " " Thumb<br>Nut .....   |
| 230625  | 13354 | Feed Dog .....   |
| 230745  | 14650 | Presser Foot .....   |
| 35983   | 11598 | Strip Wire .....   |
| 230746  | 14650 | Tape Tension Frame with six 229000   |
| 229000  | 13380 | " " Pin .....  |
| 230749  | 14650 | Throat Plate, 50 needle hole, for<br>needle sizes 14 and 15, with<br>201566B, 202534 and two 200583H     |
| 230751  | ---   | Cord Covering Attachment com-<br>plete, Nos. 35983, 200137D, 230625,<br>230744 to 230746 and 230749 .... |

## FOLDERS

For Open Shirt Fronts

| No.    | Plate | Name   |
|--------|-------|--|
| 226165 | 10923 | Presser Folder, for folding a $\frac{1}{16}$ in.<br>fold from the left, which is to be<br>stitched near the edge ..... |

### FOLDERS (DOUBLE)

For Shirt Work

|        |       |  |
|--------|-------|--|
| 225729 | 11598 | Folder, turns the upper edge under<br>and the under edge over, for M,<br>H, XXH or XXXH material ....                                    |
| 225962 | 10511 | Folder on Shank, folds the top<br>goods under and the under goods<br>over and guides a piece of goods<br>between them from the left .... |

Note: Send sample of goods to be folded.

### BENCH TUCK FOLDER

|        |       |  |
|--------|-------|--|
| 230930 | 13376 | Bed Plate (back) .....                             |
| 202293 | 10912 | Feed Dog, 21 teeth (22 teeth to the<br>inch) ..... |
| 203198 | 13355 | Presser Foot, for laying tucks ....                |
| 203199 | 13355 | " " " " narrow tucks                               |
| 203200 | 13355 | " " " " tucks toward<br>the needle .....           |
| 36387  | 5884  | Space Guide .....                                  |
| 35510  | 5884  | " " Base with 35512, 35514<br>and two 1426E .....  |
| 402D   | 5885  | Space Guide Base Screw .....                       |
| 35511  | 5885  | " " Indicator .....                                |
| 35512  | 5885  | " " Pin .....                                      |
| 35513  | 5885  | " " Stop (left) .....                              |
| 35514  | 5885  | " " " " Guide Pin..                                |
| 1426E  | 5885  | " " " " Screw Stud                                 |
| 1657D  | 5885  | " " " " Thumb Nut                                  |
| 17718  | 5885  | " " " " " " "                                      |
|        |       | Washer .....                                       |
| 35515  | 5885  | Space Guide Stop (right) .....                     |
| 1426E  | 5885  | " " " " Screw Stud                                 |
| 1657D  | 5885  | " " " " Thumb Nut                                  |
| 17718  | 5885  | " " " " " " "                                      |
|        |       | Washer .....                                       |

From the library of: Diamond Needle Corp



| No.    | Plate | Name  |
|--------|-------|---|
| 287D   | 5885  | Space Guide Thumb Screw .....   |
| 36388  | ---   | Space Guide complete, Nos. 287D,<br>35510, 35511, 35513, 35515, 36387,<br>two each 1657D and 17718 .....  |
| 202827 | 10390 | Throat Plate, 53 needle hole, for<br>needle sizes 12 and 13, with<br>202534, 202619 and two 200583H..   |
| 35517  | 5883  | Tuck Guide Arm .....  |
| 1177D  | 5885  | " " " Screw .....   |
| 35518  | 5883  | " " " Base .....  |
| 50134E | 5885  | " " " Screw Stud .....  |
| 36389  | 5883  | " " " Bracket .....   |
| 307C   | 5885  | " " " Screw Center ...  |
| 1513J  | 5885  | " " " " " Nut   |
| 36390  | 5885  | " " " Spring .....  |
| 36391  | 5884  | " " " " Plate .....   |
| 9D     | 5885  | " " " " Screw .....   |
| 423C   | 5885  | " " " Stop Screw .....  |
| 1520E  | 5885  | " " " " " Nut ..  |
| 36392  | 5883  | " " " Frame .....   |
| 36393  | 5885  | " " " Spring .....  |
| 1510E  | 5885  | " " " " Nut .....   |
| 35524  | 5885  | " " " " Washer ...  |
| 803C   | 5885  | " " " Stop Screw .....  |
| 1520E  | 5885  | " " " " " Nut ..  |
| 35511  | 5885  | " " " Indicator .....   |
| 35525  | 5883  | " " " Plate .....   |
| 1115F  | 5885  | " " " Screw .....   |
| 36394  | ---   | Tuck Guide complete, Nos. 9D, 423C,<br>803C, 1510E, 35511, 35517, 35518,<br>35524, 35525, 36389 to 36393,<br>50134E, two each 307C, 1115E,<br>1177D, 1513J, 1520E and three<br>wood screws 1½ in., No. 10 ..... |
| 244041 | ---   | Adjustable Bench Tuck Folder com-<br>plete, Nos. 36388, 36394, 202293,<br>202827, 203198 to 203200, 230930<br>and two 402D .....  |

## TUCK FOLDER

|         |       |                         |
|---------|-------|-------------------------|
| 225923  | 10321 | Folder .....            |
| 200090C | 11598 | " Adjusting Screw ..... |
| 225924  | 10321 | " Arm .....             |
| 200836E | 11598 | " Screw Stud .....      |
| 200318H | 11598 | " " " Adjusting Screw   |
| 206840  | 11598 | " " " " " "             |
|         |       | Spring Washer .....     |

| No.     | Plate | Name  |
|---------|-------|---|
| 201564B | 11598 | Folder Screw Stud Thumb Nut   |
| 202600  | 11598 | " " " " " "   |
|         |       | Washer .....  |
| 203198  | 13355 | Presser Foot, for laying tucks ....   |
| 203199  | 13355 | " " " " narrow tucks  |
| 203200  | 13355 | " " " " tucks toward<br>the needle .....  |
| 225926  | 10321 | Space Gauge .....   |
| 200843E | ---   | " " Stop Screw Stud .....   |
| 201562B | ---   | " " " " " Thumb<br>Nut .....  |
| 202603  | 10346 | Space Gauge Stop Screw Stud<br>Thumb Nut Washer .....   |
| 225927  | 10321 | Tuck Folder complete, Nos. 200090C,<br>200318H, 200836E, 200843E, 201562B,<br>201564B, 202600, 202603, 206840,<br>225923, 225924 and 225926 ..... |

## HEMMERS

### HEMMER FEET

| No.    | Plate | Name   |
|--------|-------|--|
| 225800 | 10354 | Hemmer Foot, for lace, for $\frac{1}{8}$ in. hem .....   |
| 225502 | 10354 | Hemmer Foot, for $\frac{1}{8}$ in. hem .....   |
| 225805 | 10354 | " " " lace, for $\frac{1}{8}$ in. hem .....  |
| 225504 | 10354 | Hemmer Foot, for $\frac{1}{4}$ in. hem .....   |
| 206974 | 11600 | " " " $\frac{1}{4}$ in. hem .....  |
| 225806 | 10354 | " " " $\frac{3}{8}$ in. hem .....  |
| 225503 | 10354 | " " " lace, for $\frac{3}{8}$ in. hem .....  |
| 225801 | 10393 | Hemmer Foot, for $\frac{1}{4}$ in. hem, for thick soft woolens and felling corset seams .....                |
| 225740 | 10393 | Hemmer Foot, for $\frac{1}{2}$ in. hem .....   |
| 225802 | 10393 | " " " $\frac{3}{8}$ and $\frac{1}{2}$ in. hem, for cord guiding, sews a cord within the hem .....            |
| 229843 | 11600 | Hemmer Foot, for $\frac{3}{8}$ and $\frac{1}{2}$ in. hem, for cord guiding, sews a cord within the hem ..... |

Note: Specify width wanted on order.

### PRESSER FOOT CLEFT HOLDERS

|        |       |   |
|--------|-------|---|
| 206842 | 13356 | Presser Foot Cleft Holder .....   |
| 225865 | 10355 | " " " " for use with 206998, for interchangeable Pressers and Hemmers ..... |

### HEMMERS

|        |       |   |
|--------|-------|---|
| 225807 | 10355 | Hemmer, for $\frac{1}{8}$ in. hem .....                             |
| 225808 | 10355 | " " " $\frac{1}{4}$ in. hem, for felling .....                      |
| 225809 | 10355 | " " " $\frac{1}{2}$ in. hem .....                                   |
| 225810 | 10355 | " " " $\frac{3}{8}$ in. hem .....                                   |
| 225811 | 10355 | " " " $\frac{1}{4}$ in. hem .....                                   |
| 225812 | 10355 | " " " $\frac{3}{8}$ in. hem, for "L" shaped Feed Dog 202283 only .. |

| No.    | Plate | Name   |
|--------|-------|--|
| 225813 | 10355 | Hemmer, for $\frac{1}{8}$ in. hem (Troy, long) |
| 225814 | 10355 | " " " $\frac{1}{4}$ in. hem (Troy, short)      |
| 225815 | 10355 | " " " $\frac{3}{8}$ in. hem .....              |
| 231168 | 10355 | " " " $\frac{1}{4}$ in. hem .....              |
| 225816 | 10355 | " " " $\frac{1}{4}$ in. hem .....              |
| 225817 | 10355 | " " " $\frac{3}{8}$ in. hem .....              |

### HEMMERS ON SHANK

|        |       |   |
|--------|-------|---|
| 225803 | 10353 | Hemmer on Shank, for hems of the following widths: $\frac{1}{8}$ , $\frac{1}{4}$ , $\frac{1}{2}$ , $\frac{3}{8}$ , $\frac{1}{2}$ , $\frac{3}{4}$ , $\frac{1}{2}$ and $\frac{1}{2}$ inch ..... |
|--------|-------|---|

Note: Specify width wanted on order.

|        |       |   |
|--------|-------|---|
| 225804 | 10353 | Hemmer on Shank, for hems of the following widths: $\frac{1}{2}$ , $\frac{5}{8}$ , $\frac{1}{2}$ , $\frac{3}{4}$ , $\frac{1}{2}$ , $\frac{3}{4}$ , $\frac{1}{2}$ and 1 inch ..... |
|--------|-------|---|

Note: Specify width wanted on order.

### HEMMER

For Sheets, Etc., Sizes from  $\frac{1}{2}$  to  $3\frac{1}{4}$  inches

Note: Specify width wanted on order.

|         |       |  |
|---------|-------|--|
| 225794  | ----  | Hemmer on Shank .....  |
| 200160B | 11600 | " Adjusting Screw .....  |
| 226663  | 11600 | " " " Washer ...   |
| 203075  | 10935 | " Base Plate with 225706 ...   |
| 230000  | 11599 | " " " 203075 with 200246B, 201525E, 225708, 226663 and two 200160B .....               |
| 225706  | ----  | Hemmer Base Plate Position Pin..   |
| 200246B | 11600 | " " " Screw .....  |
| 201525E | 10245 | " " " " Nut .....  |
| 225708  | 10344 | " " " Spring .....   |
| 225796  | 10321 | Hemmer complete, for $\frac{1}{2}$ to $3\frac{1}{4}$ in., Nos. 225794 and 230000 ..... |

## HEMMER

## For Hemming Pillow Cases or Other Tubular Work

For hems from  $\frac{1}{2}$  to 4 inches

Note: Specify width wanted on order.

| No.     | Plate | Name   |
|---------|-------|--|
| 203075  | 10935 | Base Plate with 225706 .....   |
| 230000  | 11599 | " " 203075 with 200246B,<br>201525E, 225708, 226663 and two<br>200160B .....                                 |
| 225706  | —     | Base Plate Position Pin .....  |
| 200246B | 11600 | " " Screw .....  |
| 201525E | 10245 | " " " Nut .....  |
| 225708  | 10344 | " " Spring .....   |
| *225764 | —     | Hemmer on Shank .....  |
| *225767 | —     | " Plate with 200857E and<br>225586 .....   |
| 226663  | 11600 | Hemmer Plate Clamp Washer....  |
| 200160B | 11600 | " " " " Screw  |
| 225586  | 11600 | " Shank Position Pin .....   |
| 200857E | 11600 | " " Screw Stud .....   |
| 225765  | 10344 | " " Switch Handle with<br>200397C and 201609 .....   |
| *201609 | —     | Hemmer Shank Switch Handle Stud  |
| 200397C | 13378 | " " " " " "  |
|         |       | Set Screw .....  |
| 204004  | 11600 | Hemmer Shank Switch Handle<br>Washer .....   |
| 225769  | 10321 | Hemmer complete, for hems $\frac{1}{2}$ to 4<br>in., Nos. 204004, 225764, 225765,<br>225767 and 230000 ..... |

## HEMMER ON SWING BRACKET

|        |       |  |
|--------|-------|--|
| 225970 | 11600 | Hemmer on Shank, made for hems<br>of the following widths: $\frac{1}{8}$ , $\frac{1}{4}$ , $\frac{1}{2}$ ,<br>$\frac{3}{8}$ , $\frac{1}{2}$ , $\frac{3}{4}$ and $\frac{1}{2}$ inch ..... |
|--------|-------|--|

Note: Specify width wanted on order.

|         |       |   |
|---------|-------|---|
| 226110  | 11599 | Hemmer Swing Bracket with<br>200369D and 200862E .....  |
| 226977  | —     | Hemmer Swing Bracket 226110 with<br>200157B, 201526E, 201563B, 225734,<br>225735 and 226071 ..... |
| 200369D | 11600 | Hemmer Swing Bracket Adjusting<br>Screw .....   |

| No.     | Plate | Name   |
|---------|-------|--|
| 225735  | 10335 | Hemmer Swing Bracket Base ....                                   |
| 200157B | 13380 | " " " " Hinge<br>Screw .....                                     |
| 201526E | 10335 | Hemmer Swing Bracket Base Hinge<br>Screw Nut .....               |
| 226071  | 10335 | Hemmer Swing Bracket Base Hinge<br>Screw Spring Washer .....     |
| 200862E | 11600 | Hemmer Swing Bracket Base Screw<br>Stud .....                    |
| 201563B | 10335 | Hemmer Swing Bracket Base Screw<br>Stud Thumb Nut .....          |
| 225734  | 10335 | Hemmer Swing Bracket Base Screw<br>Stud Washer .....             |
| 225973  | —     | Hemmer on Swing Bracket com-<br>plete, Nos. 225970 and 226977 .. |

## REVERSE HEMMER

## For Turning the Hem Under

|         |       |   |
|---------|-------|---|
| 225776  | 10346 | Hemmer, for $\frac{3}{2}$ in. hem .....                           |
| 225777  | 10346 | " Shank .....   |
| 200142B | 10346 | " " Screw .....   |
| 202603  | 10346 | " " " Washer .....  |
| 225778  | 10346 | Hemmer complete, Nos. 200142B,<br>202603, 225776 and 225777 ..... |

## REVERSE HEMMER

## For Hemming and Stitching on Lace

|         |       |   |
|---------|-------|---|
| 225779  | 10347 | Hemmer on Shank, for $\frac{3}{2}$ in. hem  |
| 225780  | 10347 | " Lace Guide .....  |
| 200142B | 10346 | " Shank Screw .....   |
| 202603  | 10346 | " " " Washer .....  |
| 225781  | 10347 | Hemmer (reverse) complete, Nos.<br>225779, 225780, two each 200142B<br>and 202603 ..... |

## HEMMER

For Hemming Tubular Articles with Movable Folder  
for Finishing Off. State Gauge Required

Made for hems from  $\frac{1}{2}$  to  $1\frac{1}{2}$  in., in steps of  $\frac{1}{32}$  inch

| No.     | Plate | Name   |
|---------|-------|--|
| 203075  | 10935 | Base Plate with 225706 .....   |
| 230000  | 11599 | " " 203075 with 200246B,<br>201525E, 225708, 226663 and two<br>200160B ..... |
| 225706  | —     | Base Plate Position Pin .....  |
| 200246B | 11600 | " " Screw .....  |
| 201525E | 10245 | " " " Nut .....  |
| 225708  | 10344 | " " Spring .....   |
| 225787  | 11599 | Hemmer on Shank .....  |
| 200460B | —     | " Adjusting Thumb Screw .....  |
| 228043  | 11600 | " " " " "<br>Washer .....  |
| 230864  | 11599 | Hemmer Plate .....   |
| 226663  | 11600 | " " Clamp Washer .....   |
| 200160B | 11600 | " " " " Screw .....  |
| 230865  | —     | Hemmer complete, Nos. 200460B,<br>225787, 228043, 230000 and 230864          |

## HEMMER

For Hemming Tubular Articles with Movable Folder  
for Finishing Off. State Gauge Required

Made for hems from  $\frac{1}{4}$  to 1 in., in steps of  $\frac{1}{32}$  inch

|         |       |   |
|---------|-------|---|
| 225790  | 10350 | Hemmer on Shank .....   |
| 225791  | 10350 | " Base Plate with 200838E ..  |
| 200838E | 10350 | " " " Screw Stud .....  |
| 201557B | 10350 | " " " " " Nut .....   |
| 225792  | 10350 | Presser Foot .....  |
| 225793  | 10350 | Hemmer complete, for hems $\frac{1}{4}$ to 1<br>in., Nos. 201557B and 225790 to<br>225792 ..... |

## PLAITER

## FOLDS TUCK PLAITS

| No.     | Plate | Name   |
|---------|-------|--|
| 225827  | 10357 | Base Plate .....   |
| 225828  | 10357 | " " Arm Bracket with two<br>200383c .....  |
| 225829  | 10358 | Base Plate Arm Shaft .....   |
| 200383c | 10246 | " " " " Set Screw ..   |
| 200579E | 10359 | " " Set Screw .....  |
| 225830  | 10358 | Folder Guide .....   |
| 200110B | 10359 | " " Set Screw .....  |
| 225831  | 10358 | " Bracket .....  |
| 225919  | —     | " " 225831 with 225830,<br>225833, two each 200110B and<br>200137c .....                         |
| 225909  | 10358 | Folder Bracket Guide Stop with<br>200382c .....  |
| 200382c | 10359 | Folder Bracket Guide Stop Set<br>Screw .....   |
| 226164  | 10359 | Folder Bracket Stop Collar with<br>200113F .....   |
| 200113F | 10359 | Folder Bracket Stop Collar Set<br>Screw .....  |
| 225833  | 10358 | Folder Bracket Stop Spring .....   |
| 200137c | 10359 | " " " " Screw .....  |
| 225835  | 10358 | Guide .....  |
| 225836  | 10358 | " Adjustable Stop .....  |
| 200169B | 10359 | " " " Screw .....  |
| 200845B | 10359 | " Screw Stud .....   |
| 200651B | 10359 | " " " Handle Screw ..  |
| 226163  | 10359 | " " " Washer .....   |
| 225839  | 10358 | Space Guide .....  |
| 225840  | 10358 | " " Bracket .....  |
| 200417A | 10359 | " " " Position Screw .....   |
| 201531E | 13380 | " " " " "<br>Nut .....   |
| 226164  | 10359 | Space Guide Bracket Stop Collar<br>with 200113F .....  |
| 200113F | 10359 | Space Guide Bracket Stop Collar<br>Set Screw .....   |
| 200462B | 10245 | Space Guide Bracket Thumb Screw .....  |
| 200110B | 10359 | " " Set Screw .....  |
| 225841  | —     | Space Guide complete, Nos. 200417A,<br>200462B, 201531E, 225839, 225840<br>and two 200110B ..... |

| No.    | Plate | Name   |
|--------|-------|--|
| 225842 | 10321 | Plaiter complete, Nos. 200169B,<br>200651B, 200845B, 225827 to 225829,<br>225835, 225836, 225841, 225909,<br>225919, 226163, two 226164 and<br>three 200579E ..... |

## RUFFLER

With Separating Blade and Disengaging Lever to Switch  
the Ruffling Blade Out of or In to Action for In-  
termittent Ruffling Such as Yoking Shirts, Etc.

| No.   | Plate | Name  |
|---|-------|---|
| 225843  | 10360 | Driving Lever .....   |
| 200255D   | 10360 | " " Hinge Screw .....   |
| 225844  | 10360 | " " Spring .....  |
| 201554D   | 10360 | " " Adjusting Nut .....   |
| 225845  | 10360 | Frame with 225959 .....   |
| 225846  | 10361 | Guide (left) with 225856 and two<br>200178D .....   |
| 225847  | 10361 | Guide (right) with 225856 and two<br>200178D .....  |
| Note: Nos. 225846 and 225847 are sent only<br>on order. |       |   |
| 200126D   | 10361 | Guide Screw .....   |
| 225848  | 10360 | Needle Bar Collar (for driving<br>225843) .....   |
| 201856  | 11600 | Needle Bar Collar Roller .....  |
| 200615F   | 10360 | " " " Screw ...   |
| 225850  | 10360 | Needle Bar Collar complete, Nos.<br>200615F, 201856 and 225848 .....  |
| 225851  | 10360 | Ruffling Blade .....  |
| 225852  | 10360 | " " Clamp .....   |
| 200175H   | 10360 | " " " Screw .....   |
| 225853  | 10360 | " " Lever with 225852,<br>225854 and two 200175H .....  |
| 200465F   | 10360 | Ruffling Blade Lever Adjusting<br>Thumb Screw .....   |
| 225854  | 10360 | Ruffling Blade Lever Adjusting<br>Thumb Screw Bushing .....   |
| 201583C   | 10360 | Ruffling Blade Lever Adjusting<br>Thumb Screw Wing Nut .....  |
| 225855  | 10360 | Ruffling Blade Switching Lever  |
| 200310C   | 10360 | " " " "<br>Hinge Screw .....  |
| 225959  | 10360 | Ruffling Blade Switching Lever<br>Stop Pin .....  |
| 225856  | 10361 | Separating Blade .....  |
| 200178D   | 11600 | " " Screw .....   |
| 225857  | 10361 | Ruffler complete, Nos. 200126D,<br>200255D, 200310C, 200465F, 201554D,<br>201583C, 225843 to 225845, 225850,<br>225851, 225853 and 225855 ..... |

## RIBBON REELS

| No.    | Plate | Name  |
|--------|-------|---|
| 226200 | —     | Ribbon Reel (6 in. diam.) with<br>225666 .....  |
| 226211 | —     | Ribbon Reel (holding projection, 6 $\frac{1}{2}$<br>in. diam.) with 213540 and 226212 |
| 225663 | 10321 | Ribbon Reel (9 in. diam.) with<br>225666 .....  |
| 226212 | 11598 | Ribbon Reel Center Pin .....  |
| 213540 | 13380 | " " " " Washer ..   |
| 225664 | 11598 | " " Supporting Spindle ..   |
| 225665 | —     | " " " " Base<br>with 225664 and two wood screws<br>$\frac{3}{4}$ in., No. 7 .....     |
| 230471 | —     | Ribbon Reel Supporting Spindle<br>Hub .....   |
| 225666 | —     | Ribbon Reel Supporting Spindle<br>Hub 230471 with 225980 .....                        |
| 225980 | —     | Ribbon Reel Supporting Spindle<br>Hub Base .....                                      |
| 226201 | —     | Ribbon Reel (6 in. diam.) complete,<br>Nos. 225665 and 226200 .....                   |
| 225976 | —     | Ribbon Reel (9 in. diam.) complete,<br>Nos. 225663 and 225665 .....                   |

## WOOD BASE

### FOR USE WITH TUCK FOLDER

|         |       |   |
|---------|-------|---|
| 79627   | —     | Bench Stand Section (back) with<br>two each 20022, 27878, 44244,<br>wood screws 1 $\frac{1}{4}$ in., No. 14 and<br>3 $\frac{1}{2}$ in., No. 14 .....      |
| 79626   | —     | Bench Stand Section (front) with<br>wood screw 1 $\frac{1}{2}$ in., No. 12, two<br>each 20022, 27878 and wood<br>screws 3 $\frac{1}{2}$ in., No. 14 ..... |
| 228170  | —     | Drip Pan .....  |
| 44244   | —     | Machine Hinge Plate .....   |
| 20022   | —     | " Rest (felt) .....   |
| 27878   | —     | " " Rivet .....   |
| 202730  | 11599 | Knee Lifter Rock Lever Rod, 8 in.<br>long, with 202456 .....  |
| *202456 | —     | Knee Lifter Rock Lever Rod Cap<br>or Oil Guard .....  |
| 79628   | —     | Bench Stand (sectional) complete,<br>Nos. 79626 and 79627 .....   |

**NUMERICAL LIST OF PARTS**  
**FOR**  
**MACHINES**  
**Nos. 61w52, 61w72, 61w84**  
**and 61w154**

**NUMERICAL LIST OF PARTS**

| No.   | Plate | Name   |
|-------|-------|--|
| 90    | 5885  | Tuck Folder Tuck Guide Bracket Spring Screw, for 36394     |
| 287d  | 5885  | Tuck Folder Space Guide Thumb Screw, for 36388             |
| 307   | 5885  | Tuck Folder Tuck Guide Bracket Screw Center, for 36394     |
| 356c  | 14171 | Knee Lifter Rock Shaft Knee Arm Hub Set Screw, for 2766    |
| 356c  | 14171 | Knee Lifter Rock Shaft Knee Plate Set Screw, for 2767      |
| 356c  | 14171 | Knee Lifter Rock Shaft Lifting Lever Set Screw, for 228238 |
| 356c  | 14171 | Knee Lifter Rock Shaft Stop Dog Set Screw, for 2770        |
| 402d  | 5885  | Tuck Folder Space Guide Base Screw, for 24494              |
| 423   | 5885  | Tuck Folder Tuck Guide Bracket Stop Screw, for 36394       |
| 803   | 5885  | Tuck Folder Tuck Guide Frame Stop Screw, for 36394         |
| 1115i | 5885  | Tuck Folder Tuck Guide Screw, for 36394                    |
| 1177d | 5885  | Tuck Folder Tuck Guide Arm Screw, for 36394                |
| 1426c | 5885  | Tuck Folder Space Guide Stop (left) Screw Stud, for 35510  |
| 1426c | 5885  | Tuck Folder Space Guide Stop (right) Screw Stud, for 35510 |
| 1507r | 13380 | Knee Lifter Rock Shaft Knee Arm Lock Nut, for 228563       |
| 1510f | 5885  | Tuck Folder Tuck Guide Frame Spring Nut, for 36394         |
| 1513d | 5885  | Tuck Folder Tuck Guide Bracket Screw Center Nut, for 36394 |
| 1520e | 5885  | Tuck Folder Tuck Guide Bracket Stop Screw Nut, for 36394   |
| 1520i | 5885  | Tuck Folder Tuck Guide Frame Stop Screw Nut, for 36394     |
| 1657d | 5885  | Tuck Folder Space Guide Stop (left) Thumb Nut, for 36388   |
| 1657d | 5885  | Tuck Folder Space Guide Stop (right) Thumb Nut, for 36388  |
| 2102  | 10881 | Bobbin Winder Tension Disc, for 225462                     |

| No.   | Plate | Name  |
|-------|-------|---|
| 2763  | 14171 | Knee Lifter Rock Shaft, for 228242 and 228243 .....   |
| 2765  | 14171 | Knee Lifter Rock Shaft Knee Arm, for 2768 .....   |
| 2766  | 14171 | Knee Lifter Rock Shaft Knee Arm Hub with 356c, for 2768 and 228243                              |
| 2767  | 14171 | Knee Lifter Rock Shaft Knee Plate with 356c, for 2768 and 228243 ..                             |
| 2768  | -     | Knee Lifter Rock Shaft Knee Arm 2765 with 2766 and 2767, for 228243                             |
| 2770  | 14171 | Knee Lifter Rock Shaft Stop Der with 356c, for 228242 and 228243                                |
| 7539  | 14171 | Knee Lifter Rock Shaft Hanger with two wood screws 1 in., No. 10, for 228242 and 228243 .....   |
| 8073  | 14171 | Knee Lifter Rock Shaft Lifting Lever Rod Swivel Spring Plunger, for 228239 .....                |
| 12361 | 13380 | Machine Hinge Connection .....  |
| 17718 | 5885  | Tuck Folder Space Guide Stop (left) Thumb Nut Washer, for 36388 .....                           |
| 17718 | 5885  | Tuck Folder Space Guide Stop (right) Thumb Nut Washer, for 36388 .....                          |
| 20022 | -     | Machine Rest, for 79626 and 79627   |
| 20093 | 14171 | Knee Lifter Rock Shaft Hanger (front) with two wood screws 1 in., No. 10, for 228242 and 228243 |
| 26608 | 13355 | Presser Foot (glass) .....  |
| 27878 | -     | Machine Rest Rivet, for 79627 .....   |
| 35510 | 5884  | Tuck Folder Space Guide Base with 35512, 35514 and two 1426e, for 36388 .....                   |
| 35511 | 5885  | Tuck Folder Space Guide Indicator, for 36388 .....  |
| 35511 | 5885  | Tuck Folder Tuck Guide Indicator, for 36394 .....   |
| 35512 | 5885  | Tuck Folder Space Guide Pin, for 35510 .....  |
| 35513 | 5885  | Tuck Folder Space Guide Stop (left), for 36388 .....  |
| 35514 | 5885  | Tuck Folder Space Guide Stop (left) Guide Pin, for 35510 .....                                  |
| 35515 | 5885  | Tuck Folder Space Guide Stop (right), for 36388 .....   |
| 35517 | 5883  | Tuck Folder Tuck Guide Arm, for 36394 .....   |
| 35518 | 5883  | Tuck Folder Tuck Guide Base, for 36394 .....  |

| No.     | Plate | Name   |
|---------|-------|--|
| 35521   | 5885  | Tuck Folder Tuck Guide Frame Spring Washer, for 36394 .....  |
| 35525   | 5883  | Tuck Folder Tuck Guide Plate, for 36394 .....  |
| 35983   | 14598 | Strip Wire, for 230751 .....   |
| 36387   | 5884  | Tuck Folder Space Guide, for 36388   |
| 36388   | -     | Tuck Folder Space Guide complete, Nos. 2870, 35510, 35511, 35513, 35515, 36387, two each 16570 and 16418, for 244011 .....   |
| 36389   | 5883  | Tuck Folder Tuck Guide Bracket, for 36394 .....  |
| 36390   | 5885  | Tuck Folder Tuck Guide Bracket Spring, for 36394 .....   |
| 36391   | 5884  | Tuck Folder Tuck Guide Bracket Spring, Plate, for 36394 .....  |
| 36392   | 5883  | Tuck Folder Tuck Guide Frame, for 36394 .....  |
| 36393   | 5885  | Tuck Folder Tuck Guide Frame Spring, for 36394 .....   |
| 36394   | -     | Tuck Guide complete, Nos. 90, 1230, 800, 1510c, 35511, 35517, 35518, 35521, 35525, 36389 to 36393, 36394, two each 300c, 1415c, 14170, 14130, 1520c and three wood screws 1½ in., No. 10, for 244011 ..... |
| 41400   | 12152 | Machine Rest Pin (wood) .....  |
| 44244   | -     | Hinge Plate, for 79627 .....   |
| 50134c  | 5885  | Tuck Folder Tuck Guide Base Screw Stud, for 36394 .....  |
| 79626   | -     | Bench Stand Section (front) with wood screw 1½ in., No. 12, two each 20022, 27878 and wood screws 3½ in., No. 14, for 79628  |
| 79627   | -     | Bench Stand Section (back) with two each 20022, 27878, 44244, wood screws 1½ in., No. 14 and 3½ in., No. 14, for 79628 .....   |
| 79628   | -     | Bench Stand (sectional) complete, Nos. 79626 and 79627 .....   |
| 120312  | 12153 | Oilor (copper plated) with 120343 ..   |
| 120343  | 12153 | " Spout, 3½ in. long, for 120342 ..  |
| 200040c | 10245 | Arm Screw .....  |
| 200035a | 14598 | Corder Arm Bracket Screw, for 225688 .....   |
| 200035c | 10245 | Feed Bar Slide Block Crank Pinch Screw, for 202298 .....   |
| 200035d | 10245 | Feed Driving Connection Crank Pinch Screw, for 202298 .....  |



| No.     | Plate | Name   |
|---------|-------|--|
| 200043c | 10246 | Feed Driving Rock Shaft Center Set Screw                                     |
| 200045c | 10246 | Feed Lifting Rock Shaft Center Set Screw                                     |
| 200047c | 10381 | Tuck Marker Shaft Driving Crank Pinch Screw, for 225939                      |
| 200054e | 10246 | Feed Driving Connection Pinch Screw, for 202297                              |
| 200054E | 10246 | Feed Lifting Connection Pinch Screw, for 202306                              |
| 200056E | 10884 | Bobbin Winder Stop Latch Screw, for 225382                                   |
| 200061c | 13378 | Tension Stud Set Screw   |
| 200074E | 13378 | Presser Foot Screw, for 202335   |
| 200079H | 13378 | Spool Holder Wire Hinge Screw, for 204297                                    |
| 200082D | 10881 | Bobbin Winder Tension Bracket Screw, for 225382                              |
| 200086c | 10248 | Needle Bar Connecting Stud Pinch Screw, for 202329                           |
| 200086E | 10248 | Presser Bar Position Guide Lever Pinch Screw, for 202338                     |
| 200086c | 10248 | Bobbin Case Lever Driving Eccentric Connection Lever Pinch Screw, for 206730 |
| 200090c | 11598 | Tuck Folder Adjusting Screw, for 225927                                      |
| 200106E | 10245 | Feed Dog Screw, for 203121   |
| 200110B | 10359 | Plaiter Folder Guide Set Screw, for 225919                                   |
| 200110B | 10359 | Plaiter Space Guide Set Screw, for 225841                                    |
| 200113E | 10359 | Plaiter Folder Bracket Stop Collar Set Screw, for 226164                     |
| 200113E | 10359 | Plaiter Space Guide Bracket Stop Collar Set Screw, for 226164                |
| 200125E | 10381 | Tuck Marker Set Screw, for 225936  |
| 200126D | 10361 | Ruffler Guide Screw, for 225857  |
| 200132E | 10247 | Take-up Lever Oiling Felt Screw  |
| 200132E | 10247 | Thread Controller Spring Stop Screw  |
| 200137D | 10359 | Cord Guide and Strip Folder Screw, for 230751                                |
| 200137c | 10359 | Plaiter Folder Bracket Stop Spring Screw, for 225919                         |
| 200141E | 10248 | Needle Set Screw, for 202326   |
| 200142B | 10346 | Hemmer Shank Screw, for 225778 and 225781                                    |
| 200142E | 10346 | Tuck Marker Tuck Creaser Plate Spring Screw, for 225707                      |

| No.     | Plate | Name  |
|---------|-------|---|
| 200145c | 11671 | Hook Washer Screw, for 244011 and 244023                        |
| 200157E | 13380 | Attachment Screw  |
| 200157E | 13380 | Hemmer Swing Bracket Base Hinge Screw, for 226977               |
| 200160a | 11600 | Hemmer Adjusting Screw, for 230000                              |
| 200160c | 11600 | Hemmer Plate Clamp Washer Screw, for 230000                     |
| 200161D | 10217 | Needle Bar Connecting Link Oil Guard Screw                      |
| 200164a | 10309 | Folder Slide Adjusting Thumb Nut Guide Screw, for 225623        |
| 200164a | 10309 | Folder Slide Cap Screw, for 225623                              |
| 200169c | 10359 | Plaiter Guide Adjustable Stop Screw, for 225842                 |
| 200172B | 10381 | Tuck Marker Tuck Creaser Slide Spring Screw, for 225707         |
| 200175a | 10360 | Presser Foot Spring Guide Screw, for 203037 and 229871          |
| 200175a | 10360 | Presser Foot Strip Guide Bar Plate Screw, for 202366            |
| 200175a | 10360 | Ruffling Blade Clamp Screw, for 225853                          |
| 200175b | 11598 | Pressure Spring Screw, for 225623                               |
| 200178D | 11600 | Ruffling Separating Blade Screw, for 225846 and 225847          |
| 200179a | 10361 | Tuck Marker Guide Tuck Smoothing Spring Screw, for 244028       |
| 200185a | 10325 | Presser Foot Bracket Bow Screw, for 225699, 225930 and 225940   |
| 200205c | 10245 | Feed Bar Slide Block Hinge Screw, for 203124                    |
| 200246c | 11600 | Hemmer Base Plate Screw, for 230000                             |
| 200255a | 10360 | Ruffler Driving Lever Hinge Screw, for 225857                   |
| 200260D | 13375 | Presser Bar Lifting Releasing Lever Bracket Guide Screw         |
| 200262a | 10248 | Knee Lifter Connection Lever Hinge Screw, for 244035 and 244037 |
| 200262a | 10248 | Knee Lifter Lifting Lever Hinge Screw                           |
| 200274c | 10381 | Tuck Marker Shaft Driving Crank Roller Screw Stud, for 201813   |
| 200278a | 10244 | Arm Cap Screw   |
| 200299H | 10884 | Bobbin Winder Stop Latch Trip Lever Hinge Screw, for 225382     |
| 200310c | 10360 | Ruffling Blade Switching Lever Hinge Screw, for 225857          |

| No.     | Plate | Name  |
|---------|-------|---|
| 200318u | 11598 | Tuck Folder Screw Stud Adjusting Screw, for 225927        |
| 200327c | 10244 | Arm Shaft Connection Belt Pulley Set Screw, for 202252    |
| 200328c | 10244 | Balance Wheel Position Screw, for 202255                  |
| 200333c | 13378 | Bobbin Case Lever Bushing Set Screw, for 244021           |
| 200335c | 10244 | Balance Wheel Set Screw, for 202255                       |
| 200335c | 10244 | Needle Bar Crank Set Screw, for 202328                    |
| 200338c | 10244 | Arm Shaft Bushing Set Screw                               |
| 200340c | 11598 | Corder Arm Adjusting Screw, for 225681                    |
| 200346c | 10245 | Hook Shaft Bushing (back) Set Screw                       |
| 200346c | 10245 | Hook Shaft Bushing (front) Set Screw                      |
| 200352c | 10248 | Needle Bar Bushing Set Screw                              |
| 200352c | 10248 | Presser Bar Bushing Set Screw                             |
| 200352c | 10248 | " " Position Guide Set Screw                              |
| 200355u | 10252 | Thread Guide Set Screw                                    |
| 200357e | 10244 | Arm Shaft Oil Packing Stop Screw, for 202249 and 202250   |
| 200368u | 13378 | Thread Guide Set Screw                                    |
| 200368u | 13378 | " Retainer Stud Set Screw                                 |
| 200369d | 11690 | Hemmer Swing Bracket Adjusting Screw, for 226110          |
| 200374c | 13375 | Needle Bar Connecting Link Stud Set Screw, for 202328     |
| 200380c | 13378 | Bobbin Case Lever Driving Eccentric Set Screw, for 244018 |
| 200380c | 13378 | Bobbin Winder Pulley Set Screw, for 202473                |
| 200382c | 10359 | Feed Lifting Connection Eccentric Set Screw, for 202307   |
| 200382c | 10359 | Plaiter Folder Bracket Guide Stop Set Screw, for 225999   |
| 200383c | 10246 | Feed Driving Eccentric Regulating Screw Check Screw       |
| 200383c | 10246 | Plaiter Base Plate Arm Shaft Set Screw, for 225828        |
| 200383c | 10246 | Takeup Lever Hinge Stud Set Screw                         |
| 200397c | 13378 | Hemmer Shank Switch Handle Stud Set Screw, for 225765     |
| 200417A | 10359 | Plaiter Space Guide Bracket Position Screw, for 225841    |

| No.     | Plate | Name   |
|---------|-------|--|
| 200428c | 10248 | Needle Bar Crank Position Screw, for 202328  |
| 200429c | 10246 | Feed Driving Eccentric Regulating Screw  |
| 200437c | 10246 | Feed Lifting Connection Eccentric Position Screw, for 202307                       |
| 200444c | 13375 | Bobbin Case Lever Driving Eccentric Spot Screw, for Machines Nos. 61w84 and 61w154 |
| 200444c | 13375 | Hook Counter Balance Position Screw, for 244013 and 244018                         |
| 200459d | 13375 | Cloth Guide Thumb Screw, for Machines Nos. 61w52 and 61w72                         |
| 200460c |       | Hemmer Adjusting Thumb Screw, for 230865   |
| 200462b | 10245 | Face Plate Thumb Screw   |
| 200462b | 10245 | Plaiter Space Guide Bracket Thumb Screw, for 225841                                |
| 200465c | 10359 | Ruffling Blade Lever Adjusting Thumb Screw, for 225857                             |
| 200469c | 13378 | Tuck Marker Guide Thumb Screw, for 244031  |
| 200475b | 13378 | Presser Bar Thumb Screw Thumb Set Screw  |
| 200481b | 10381 | Tuck Marker Shaft Stop Collar Thumb Screw, for 225943                              |
| 200488c | 13380 | Presser Foot Strip Guide Thumb Screw, for 231235                                   |
| 200492b | 13378 | Presser Bar Thumb Screw (pressure regulating)                                      |
| 200502b | 10246 | Arm Shaft Bushing (front) Oil Packing Thumb Screw                                  |
| 200529c | 14171 | Knee Lifter Rock Lever Rod Set Screw, for 228241                                   |
| 200543b | 13356 | Presser Foot Screw, for 206998   |
| 200545c | 10245 | Feed Driving Connection Hinge Screw  |
| 200545c | 10215 | Feed Lifting Connection Hinge Screw  |
| 200567u |       | Tuck Marker Shaft Bracket Base Plate Screw, for Machine No. 61w72                  |
| 200575u | 13378 | Spool Holder Base Screw  |
| 200577u | 10245 | Bed Plate (back) Screw, for Machines Nos. 61w52, 61w84 and 61w154                  |
| 200577u | 10215 | Throat Plate Screw   |
| 200579c | 10359 | Tuck Marker Shaft Bracket Screw, for 225937  |

| No.     | Plate | Name   |
|---------|-------|--|
| 200579E | 10359 | Plaiter Base Plate Set Screw, for 225842 .....   |
| 200582H | 10252 | Thread Guide Screw .....   |
| 200582H | 10252 | Throat Plate Bobbin Case Stop Screw, for 202811, 202816, 202963 and 225622 .....   |
| 200583H | 13378 | Bobbin Case Lever Driving Eccentric Washer Screw, for 244019 .....   |
| 200583H | 13378 | Throat Plate Bobbin Case Stop Screw, for 202812, 202815, 202947 to 202819, 202822, 202824, 202827 to 202831, 202951, 202969, 203003, 203056, 203073, 203111, 203113, 206975, 207076, 226000, 230749 and 230833 ..... |
| 200592C | 13378 | Bobbin Case Tension Spring Screw, for 206733 .....   |
| 200594C | 11671 | Bobbin Case Tension Spring Screw, for 202533 .....   |
| 200596F | 11671 | Hook Gib Screw, for 244014 and 244023 .....  |
| 200602E | 10244 | Arm Shaft Connection Belt Pulley Position Screw, for 202952 .....  |
| 200607C | 10246 | Feed Driving Eccentric Regulating Bracket Plunger Spring Stop Screw .....  |
| 200614C | 11671 | Hook Gib Hinge Screw, for 244011 and 244023 .....  |
| 200615F | 10360 | Ruffler Needle Bar Collar Roller Screw, for 225850 .....   |
| 200625F | 10247 | Tension Stud with 204925, for 20409  |
| 200641C | 10246 | Feed Bar Hinge Screw (driving), for 203122 and 206860 .....  |
| 200651B | 10359 | Plaiter Guide Screw Stud Handle Screw, for 225842 .....  |
| 200653C | 13375 | Presser Bar Lifter Hinge Screw .....   |
| 200768E | 10309 | Folder Slide Adjusting Screw, for 225613 .....   |
| 200836E | 11598 | Tuck Folder Screw Stud, for 229927   |
| 200838E | 10350 | Hemmer Base Plate Screw Stud, for 225791 .....   |
| 200842F | 13378 | Take up (auxiliary) Screw .....  |
| 200843E | —     | Tuck Folder Space Gauge Stop Screw Stud, for 225927 .....  |
| 200845B | 10359 | Plaiter Guide Screw Stud, for 225842   |
| 200851B | 10222 | Corder Arm Bracket Locking Thumb Screw, for 225685 .....   |
| 200852B | 10381 | Tuck Marker Shaft Rock Lever Pinch Screw, for 225942 .....   |

| No.     | Plate | Name  |
|---------|-------|---|
| 200857F | 11600 | Hemmer Shank Screw Stud, for 225767 .....   |
| 200862F | 11600 | Hemmer Swing Bracket Base Screw Stud, for 226110 .....                                      |
| 200893B | 11598 | Guide (back) Thumb Screw, for 225623 .....  |
| 200893B | 11598 | Guide (front) Thumb Screw, for 225623 .....   |
| 200904F | 13355 | Presser Foot Adjustable Spring Guide Screw, for 206790 .....                                |
| 200964F | 13363 | Bobbin Case Latch Stop Screw, for 206734 .....  |
| 200983C | 11671 | Bobbin Case Tension Spring Regulating Screw, for 202533 .....                               |
| 201014  | 10245 | Feed Driving Eccentric Regulating Bracket Hinge Screw, for 203134                           |
| 201014  | 10245 | Feed Driving Eccentric Regulating Bracket Stop Screw, for 203134 .....                      |
| 201043F | 13363 | Bobbin Case Tension Spring Regulating Screw, for 206733 .....                               |
| 201048C | 13375 | Hook Shaft Connection Belt Pulley Set Screw, for 202323 .....                               |
| 201194F | 13363 | Bobbin Case Lever Driving Eccentric Connection Lever Hinge Screw Stud, for 244020 .....     |
| 201499C | 10884 | Bobbin Winder Tension Stud, for 225461 .....  |
| 201518C | 10245 | Feed Bar Slide Block Hinge Screw Nut, for 203124 .....                                      |
| 201518E | 10245 | Feed Driving Connection Hinge Screw Nut .....   |
| 201518F | 10245 | Feed Lifting Connection Hinge Screw Nut .....   |
| 201520  | 10246 | Feed Bar Hinge Screw Nut, for 203122 and 206860 .....                                       |
| 201524  | 13378 | Bobbin Case Lever Driving Eccentric Connection Lever Hinge Screw Stud Nut, for 244020 ..... |
| 201525C | 10245 | Hemmer Base Plate Screw Nut, for 230000 .....   |
| 201525E | 10245 | Feed Driving Eccentric Regulating Bracket Hinge Screw Nut, for 203134 .....                 |
| 201525F | 10245 | Feed Driving Eccentric Regulating Bracket Stop Screw Nut, for 203134 .....                  |
| 201526F | 10335 | Hemmer Swing Bracket Base Hinge Screw Nut, for 226977 .....                                 |
| 201531F | 13380 | Plaiter Space Guide Bracket Position Screw Nut, for 225841 .....                            |

| No.     | Plate | Name  |
|---------|-------|---|
| 201533E | 11598 | Corder Arm Adjusting Screw Nut, for 225684  |
| 201554D | 10360 | Ruffler Driving Lever Spring Adjusting Nut, for 225857  |
| 201557B | 10350 | Hemmer Base Plate Screw Stud Nut, for 225793  |
| 201562B | ---   | Tuck Folder Space Gauge Stop Screw Stud Thumb Nut, for 225927                                   |
| 201563B | 10335 | Hemmer Swing Bracket Base Screw Stud Thumb Nut, for 226977                                      |
| 201564B | 11598 | Tuck Folder Screw Stud Thumb Nut, for 225927  |
| 201566B | 13357 | Cord Guide and Strip Folder Thumb Nut, for 220749 and 220833                                    |
| 201572B | 10881 | Bobbin Winder Tension Stud Thumb Nut, for 225462  |
| 201572B | 10881 | Tension Thumb Nut, for 202409   |
| 201583C | 10360 | Ruffling Blade Lever Adjusting Thumb Screw Wing Nut, for 225857                                 |
| *201609 | ---   | Hemmer Shank Switch Handle Stud, for 225765   |
| 201813  | 13378 | Tuck Marker Shaft Driving Crank Roller 201829 with 200274E, for 225945                          |
| 201829  | 10381 | Tuck Marker Shaft Driving Crank Roller, for 201813  |
| 201856  | 11600 | Ruffler Needle Bar Collar Roller, for 225850  |
| 202005  | 10245 | Arm Screw Washer  |
| *202056 | ---   | Bobbin Case Latch Pin, for 202333   |
| 202068  | 12153 | Spool Holder Base, for 204297   |
| 202090  | 13356 | Presser Foot Hinge Pin, for 202351, 202371, 202372, 202323, 229863 to 229865, 229867 and 229868 |
| 202091  | 10252 | Thread Retainer Sleeve, for 204059  |
| 202092  | 10252 | " " Spring, for 204059  |
| 202115  | 13379 | Tuck Marker Tuck Greaser Plate Spring, for 225797   |
| 202135  | 10245 | Face Plate Position Pin   |
| 202243  | 13351 | Arm Shaft Bushing (back) with 202244  |
| 202244  | ---   | Arm Shaft Bushing Oil Packing (wick), for 202243 and 207080                                     |
| 202247  | 10667 | Arm Cap   |
| 202248  | 10244 | " " Screw Washer  |
| 202249  | 13351 | " Shaft with 200357c and 202400, for Machines Nos. 61w53, 61w72 and 61w81                       |

| No.    | Plate | Name  |
|--------|-------|---|
| 202250 | 13365 | Arm Shaft with 200357c and 202400, for Machine No. 61w154                         |
| 202252 | 10244 | Arm Shaft Connection Belt Pulley with 200327c, 200302c and two 202253, for 203134 |
| 202253 | 10244 | Arm Shaft Connection Belt Pulley Spring Flange, for 202252                        |
| 202254 | ---   | Needle Bar Connecting Link Stud Oil Packing (wick), for 202333                    |
| 202255 | 13351 | Balance Wheel (belt groove 2 1/2 in. diam.) with 200325c and 200335c              |
| 202260 | ---   | Hook Shaft Oil Packing (wick)   |
| 202265 | 11671 | Bobbin  |
| 202267 | 11671 | " Case Latch, for 202533  |
| 202269 | 11671 | " " Plunger, for 202533   |
| 202270 | 11671 | " " Spring, for 202533  |
| 202271 | 10667 | Face Plate  |
| 202275 | 10667 | Feed Bar, for 203122 and 206860   |
| 202276 | 10245 | " " Slide Block, for 203124   |
| 202277 | ---   | Bobbin Winder Frame Oil Packing (wick), for 225453                                |
| 202277 | ---   | Feed Driving Connection Oil Packing (wick), for 202297                            |
| 202277 | ---   | Feed Lifting Connection Oil Packing (wick), for 202296                            |
| 202277 | ---   | Take-up Lever Driving Stud Oil Packing (wick), for 202399                         |
| 202278 | 10913 | Feed Dog, for binding, for 202811   |
| 202281 | 10913 | " " " 202815  |
| 202282 | 10913 | " " " general muslin work, for 202818, 202951, 203073, 203113 and 203124          |
| 202283 | 10913 | Feed Dog, for handkerchief hemming, knit goods and shoe lining, for 202819        |
| 202284 | 10913 | Feed Dog, for binding dress shields, for 202812                                   |
| 202287 | 10913 | Feed Dog, for muslin work and gathering, for 202822                               |
| 202289 | 10913 | Feed Dog, for 202817  |
| 202290 | 10912 | " " " special work, for 202824  |
| 202293 | 10912 | Feed Dog, 21 teeth (27 teeth to the inch), for 202827 and 244041                  |
| 202294 | 10912 | Feed Dog, for tucking, for 202828, 202830 and 244032                              |
| 202295 | 10912 | Feed Dog, for tucking, for 202829   |
| 202296 | 10912 | " " " " 202831  |
| 202297 | 10667 | " Driving Connection with 200054 and 202277                                       |

| No.     | Plate | Name  |
|---------|-------|---|
| 202298  | 10245 | Feed Bar Slide Block Crank with 200038c, for 203124                   |
| 202298  | 10245 | Feed Driving Connection Crank with 200038c                            |
| 202300  | 10246 | Feed Driving Eccentric Regulating Bracket, for 203124                 |
| 202301  | 10246 | Feed Driving Eccentric Regulating Bracket Plunger                     |
| 202302  | 10248 | Knee Lifter Connection Lever Lifting Rod Cotter Pin, for 20241        |
| 202303  | 13377 | Feed Driving Rock Shaft, for 200860                                   |
| 202304  | 13365 | " " " " " 200122  |
| 202305  | 10245 | " " " " " Connection  |
| 202305  | 10245 | " Lifting Rock Shaft Centre   |
| 202306  | 10667 | " " " Connection with 200541 and 202277                               |
| 202307  | 10246 | Feed Lifting Connection Eccentric with 200382c and 200427c            |
| 202308  | 13377 | Feed Lifting Rock Shaft, for Machines Nos. 61w52, 61w72 and 61w84     |
| 202310  | 13376 | Feed Regulating Spindle with 202311, 202443 and 202649                |
| *202311 |       | Feed Regulating Spindle Head for 202310                               |
| *202319 |       | Hook Shaft, 13 in. long, for 21022                                    |
| *202320 |       | " " " " " 11 in. long, for 21041                                      |
| 202321  | 10245 | " " Bushing (back)  |
| 202322  | 10245 | " " " " (front)   |
| 202323  | 10244 | " " " Connection Belt Pulley with 202324 and two 201048               |
| 202324  | 10244 | Hook Shaft Connection Belt Pulley Spring Flange, for 202323           |
| 202326  | 10248 | Needle Bar with 200411, for 200423                                    |
| 202327  | 10248 | " " Bushing, for 203123   |
| 202328  | 13376 | " " Crank with 20035c, 200428c, 202323 and two 20034c, for 203117     |
| 202329  | 10248 | Needle Bar Connecting Stud 200891 with 200086c and 202330, for 203117 |
| 202330  |       | Needle Bar Connecting Stud Oil Packing (wick), for 202329             |
| 202331  | 10248 | Needle Bar Connecting Link, for 203117                                |
| 202333  | 10248 | Needle Bar Connecting Link Stud with 202254, for 202328               |
| 202335  | 10667 | Presser Bar 241033 with 200074, for 206398                            |

| No.    | Plate | Name   |
|--------|-------|--|
| 202337 | 13375 | Presser Bar Position Guide   |
| 202338 | 13375 | " " " " " Lever with 200086c   |
| 202339 | 13375 | Presser Bar Lifter   |
| 202343 | 13378 | " " " Spring (light)   |
| 202346 | 13378 | " " " " " Stop Rod   |
| 202351 | 10927 | Presser Foot (hinged) complete, 46 needle hole, Nos. 202090, 202924 and 229955, for knit goods, for Machines Nos. 61w52 and 61w84                                      |
| 202354 | 10926 | Presser Foot, for $\frac{3}{16}$ and $\frac{5}{16}$ in. stitching margins, for collar and cuff work, for Machines Nos. 61w52 and 61w84                                 |
| 202355 | 13378 | Presser Bar Thumb Screw Thumb Set Screw Packing (brass)  |
| 202356 | 10263 | Presser Foot, for Landing, for Machines Nos. 61w52 and 61w84   |
| 202361 | 10926 | Presser Foot, for Landing, for Machines Nos. 61w52 and 61w84   |
| 202365 | 10926 | Presser Foot, for stitching margins from $\frac{3}{8}$ to $\frac{3}{4}$ in. in steps of $\frac{1}{16}$ in., with 200175c and 202810, for Machines Nos. 61w52 and 61w84 |
| 202368 | 10259 | Presser Foot (deep grooved) (grooved to left of needle hole), from 4 to 16 cords to the in., as ordered for top cording, for Machines Nos. 61w52 and 61w84             |
| 202369 | 10259 | Presser Foot (deep grooved) (grooved to left of needle hole), from 4 to 16 cords to the in., as ordered for top cording, for Machine No. 61w84                         |
| 202370 | 10259 | Presser Foot (deep grooved) (grooved to right of needle hole), from 4 to 16 cords to the in., as ordered, for top cording, for Machines Nos. 61w52 and 61w84           |
| 202371 | 13356 | Presser Foot (hinged) complete, Nos. 202090, 202924 and 203035, for umbrella hemming, for Machines Nos. 61w52 and 61w84  |
| 202372 | 13356 | Presser Foot (hinged) complete, Nos. 202090, 202924 and 203034, for handkerchief hemming, for Machines Nos. 61w52 and 61w84  |
| 202373 | 13355 | Presser Foot, for gathering, for Machines Nos. 61w52 and 61w84   |

| No.     | Plate | Name  |
|---------|-------|---|
| 202375  | 10926 | Presser Foot for mattress binding, for Machines Nos. 61w52 and 61w81                      |
| 202376  | 10926 | Presser Foot for mattress binding, for Machines Nos. 61w52 and 61w81                      |
| 202390  | 10263 | Presser Foot, for front steel stitching in corset work, for Machines Nos. 61w52 and 61w81 |
| 202397  | 13378 | Take up (auxiliary) Nos. 202398 to 202400, for 203117                                     |
| 202398  | 10247 | Take up Lever   |
| 202399  | 10247 | " " Driving Stud with 202277  |
| 202400  | 10247 | Take up Lever Hinge Stud with 202423  |
| 202401  | 10247 | Take up Lever Oiling Pin  |
| 202404  | 10247 | Tension Release Plunger   |
| 202405  | 10247 | " " Washer, for 202409  |
| 202407  | 10881 | Bobbin Winder Tension Spring, for 225462  |
| 202407  | 10881 | Tension Spring, for 202409  |
| 202409  | 10252 | Tension complete, Nos. 2006251, 201572a, 202405, 202407, 202410, 244097 and 244008        |
| 202410  | 10252 | Thread Control Spring, for 202409   |
| 202411  | 10252 | " " " Stop  |
| 202413  | 10252 | " Guide   |
| 202414  | 10252 | " " " "   |
| 202415  | 10252 | " " " "   |
| 202417  | 10252 | " " " "   |
| 202418  | 10929 | Presser Foot  |
| 202423  | ----  | Take up Lever Hinge Stud Oil Packing (twice), for 202400                                  |
| 202443  | 10244 | Feed Regulating Spindle Head Pin, for 202310  |
| 202447  | 13376 | Knee Lifter Connection Lever Lifting Rod with 202302, for 244025 and 244037               |
| *202456 | ----  | Knee Lifter Rock Lever Rod Cap or Oil Guard, for 202730                                   |
| 202473  | 10885 | Bobbin Winder Pulley with 200380c, for 225382   |
| 202478  | 10884 | Bobbin Winder Stop Latch Trip Lever, for 225382   |
| 202500  | 13378 | Bobbin Case Lever, for 244021   |
| 202501  | 13378 | " " Bushing, for 244021   |

| No.     | Plate | Name   |
|---------|-------|--|
| 202529  | 10926 | Presser Foot (split), for gathering  |
| 202530  | 13351 | Arm Shaft Connection Bell  |
| 202533  | 11671 | Bobbin Case complete, Nos. 200591c, 200581c, 202056, 202267, 202269, 202270, 202716 and 202806, for 244032   |
| 202534  | 10390 | Thread Plate Bobbin Case Stop, for 202311, 202812, 202815 to 202819, 202822, 202824, 202827 to 202831, 202951, 202969, 203053, 203056, 203063, 203073, 203111, 203113, 203075, 207076, 225622, 226000, 226049 and 230833 |
| 202572  | 13356 | Presser Foot Hinge Pin, for 231238   |
| 202595  | 10246 | Feed Driving Eccentric Regulating Bracket Plunger Spring   |
| 202600  | 11598 | Foot Folder Screw Stud Thumb Nut Washer, for 225927  |
| 202602  | 10246 | Foot Folder Space Gauge Stop Screw Stud Thumb Nut Washer, for 225927   |
| 202603  | 10246 | Heavier Shank Screw Washer, for 225778 and 225781  |
| 202619  | 13375 | Thread Plate Bobbin Case Stop Position Pin, for 202812, 202815 to 202819, 202822, 202824, 202827 to 202831, 202951, 202969, 203053, 203056, 203063, 203073, 203111, 203113, 203075, 207076, 225622 and 226000            |
| 202619  | 13375 | Feed Regulating Spindle Head Position Pin, for 202310  |
| 202651  | 13365 | Foot Lifting Rock Shaft, for Machine No. 61w154  |
| 202716  | 11671 | Bobbin Case Tension Spring, for 202533   |
| 202730  | 11599 | Knee Lifter Rock Lever Rod, 8 in. long, with 202456  |
| *202806 |       | Bobbin Case, for 202533  |
| 202807  | 10925 | Presser Foot Spring Guide, for 229871  |
| 202809  | 10927 | Presser Foot Adjustable Spring Guide, for 206799   |
| 202810  | 10926 | Presser Foot Spring Guide, for 202366  |
| 202811  | 13354 | Thread Plate, 50 needle hole, for needle sizes 11 and 15, with 202534, 244026 and two 2005820, for binding corsets and similar work, for 202278  |

| No.    | Plate | Name   |
|--------|-------|--|
| 202812 | 10390 | Throat Plate, 46 needle hole, for needle sizes 16 and 18, with 202534, 202619 and two 200583u, for 202284 .....                                      |
| 202815 | 10391 | Throat Plate, 53 needle hole, for needle sizes 12 and 13, with 202534, 202619 and two 200583u, for tucking work, for 202281 .....                    |
| 202816 | 10391 | Throat Plate, 50 needle hole, for needle sizes 14 and 15, with 202534, 202619 and two 200583u, for top cording for 203136 .....                      |
| 202817 | 10391 | Throat Plate, 60 needle hole, for needle size 8 and 9, with 202534, 202619 and two 200583u, for fine shirt work, for 202289, 207053 and 207054 ..... |
| 202818 | 13354 | Throat Plate, 50 needle hole, for needle sizes 11 and 15, with 202534, 202619 and two 200583u, for 202282, 207055 and 207056 ..                      |
| 202819 | 10391 | Throat Plate, 50 needle hole, for needle size 11 and 15, with 202534, 202619 and two 200583u for 202283, 207051 and 207052 ..                        |
| 202822 | 10391 | Throat Plate, 50 needle hole, for needle sizes 14 and 15, with 202534, 202619 and two 200583u, for muslin work and gathering, for 202287 .....       |
| 202824 | 10390 | Throat Plate, 50 needle hole, for needle sizes 14 and 15, with 202534, 202619 and two 200583u, for special work, for 202290 .....                    |
| 202827 | 10390 | Throat Plate, 53 needle hole, for needle sizes 12 and 13, with 202534, 202619 and two 200583u, for 202293 and 241941 .....                           |
| 202828 | 13354 | Throat Plate, 53 needle hole, for needle sizes 12 and 13, with 202534, 202619 and two 200583u, for tucking with Tuck Folder, for 202294 .....        |
| 202829 | 10390 | Throat Plate, 50 needle hole, for needle sizes 12 and 13, with 202534, 202619 and two 200583u, for special tucking, for 202295 .....                 |

| No.    | Plate | Name  |
|--------|-------|---|
| 202830 | 13380 | Throat Plate, 53 needle hole, for needle sizes 12 and 13, with 202534, 202619 and two 200583u, for 202294 and 241932 .....        |
| 202831 | 10391 | Throat Plate, 50 needle hole, for needle sizes 14 and 15, with 202534, 202619 and two 200583u, for 202296 .....                   |
| 202924 |       | Presser Foot Shank, for 202351, 202371, 202372, 203323, 229863 to 229865, 229867, 229868 and 231238                               |
| 202951 | 13357 | Throat Plate, 56 needle hole, for needle sizes 10 and 11, with 202534, 202619 and two 200583u, for 202292, 207055 and 207056 ..   |
| 202969 | 10917 | Throat Plate, 50 needle hole, for needle sizes 11 and 15, with 202534, 202619 and two 200583u, for fine shirt work, for 202970 .. |
| 202970 | 10912 | Feed Dog, for general muslin work, for 202969 .....   |
| 203009 |       | Presser Foot Plate, for 229864 .....  |
| 203010 | "     | " " " " 229863 .....  |
| 203011 | "     | " " " " 229867 .....  |
| 203012 | "     | " " " " 229868 .....  |
| 203024 | "     | " " " " 229865 .....  |
| 203034 | "     | " " " " 203372 .....  |
| 203035 | "     | " " " " 203371 .....  |
| 203037 | "     | " " " " with 231235 to 231237 and six 200175u, for 231238   |
| 203052 | 10917 | Throat Plate, 53 needle hole, for needle sizes 12 and 13, with 202534, 202619 and two 200583u, for 203072 .....                   |
| 203056 | 10917 | Throat Plate, 50 needle hole, for needle sizes 14 and 15, with 202534, 202619 and two 200583u, for tucking, for 203071 .....      |
| 203063 | 10917 | Throat Plate, 50 needle hole, for needle sizes 14 and 15, with 202534, 202619 and two 200583u, for special work, for 203083 ..... |
| 203071 | 10912 | Feed Dog for 203056 and 206975 ..   |
| 203072 | 10912 | " " " 203053 .....  |
| 203073 | 10917 | Throat Plate, 46 needle hole, for needle sizes 16 and 18, with 202534, 202619 and two 200583u, for 202282, 207055 and 207056 ..   |
| 203075 | 10935 | Heelmer Base Plate with 225706, for 230000 .....  |

| No.  | Plate | Name  |
|--|-------|---|
| 203083                                       | 10912 | Feed Dog, for 203063 .....  |
| 203100                                       | ---   | Arm Shaft Oil Packing (wick), for 202249 and 202259 .....   |
| 203101                                       | ---   | Hook Oil Wick, for 244944 and 244923 .....  |
| 203111                                       | 13357 | Throat Plate, 50 needle hole, for needle sizes 14 and 15, with 202534, 202619 and two 200583a, for regular cloth work, for 203417 .....                     |
| 203113                                       | 13357 | Throat Plate, 40 needle hole, for needle sizes 20 and 22, with 202534, 202619 and two 200583a, for general muslin work, for 202282, 202955 and 207056 ..... |
| 203117                                       | ---   | Needle Bar Crank 202328 with 202329, 202331 and 202398 to 202400 .....  |
| 203121                                       | ---   | Feed Driving Rock Shaft 206860 with 202292 and two 200406c, for Machines Nos. 61w52, 61w72 and 61w84 .....  |
| 203122                                       | ---   | Feed Driving Rock Shaft 203304 with 200644c, 204527c and 202275, for Machine No. 61w154 .....   |
| 203123                                       | ---   | Needle Bar Bushing 202327 with 202326 .....   |
| 203124                                       | ---   | Feed Bar Slide Block Crank 202298 with 200205c, 204548c and 202276 .....  |
| 203134                                       | ---   | Feed Driving Regulating Bracket 202300 with 202252, two each 204044c and 204254c .....  |
| 203136                                       | 13354 | Feed Dog, for 202846 .....  |
| 203172                                       | 10248 | Needle Bar Crank Friction Washer .....  |
| 203173                                       | 13354 | Feed Dog, for 226000 .....  |
| 203177                                       | 13380 | Presser Foot, for 244032 .....  |
| 203179                                       | 10926 | " " " $\frac{1}{8}$ in. stitching margin, for collar and cuff work, for Machines Nos. 61w52 and 61w84 .....   |
| 203187                                       | 13380 | Presser Foot, for tack marking or creasing, for 244032 .....  |
| Nos. 203198 to 203200, for 225979 and 244044 |       |   |
| 203198                                       | 13355 | Presser Foot, for laying tucks .....  |
| 203199                                       | 13355 | " " " " narrow tucks .....  |
| 203200                                       | 13255 | " " " " tucks toward the needle .....   |
| 203322                                       | ---   | Presser Foot Plate, for 203323 .....  |

| No.    | Plate | Name   |
|--------|-------|--|
| 203323 | 13356 | Presser Foot (hinged) complete, 50 needle hole, Nos. 202090, 202924 and 203322 .....   |
| 203417 | 13354 | Feed Dog, for 203111 .....   |
| 204004 | 14600 | Hammer Shank Switch Handle Washer, for 225769 .....  |
| 204058 | 10252 | Thread Retainer Stud, for 204059 .....   |
| 204059 | ---   | Thread Retainer complete, Nos. 202091, 202092 and 204058 .....   |
| 204225 | 14174 | Knee Lifter Rock Shaft Lifting Lever Rod Swivel Spring, for 228233 .....   |
| 204225 | 13375 | Arm Position Pin .....   |
| 204296 | 12153 | Spool Holder Wire, for 204297 .....  |
| 204297 | 12153 | Spool Holder complete, Nos. 2000730, 202068 and 204296 .....   |
| 204925 | 13378 | Tension Stud Washer, for 200625r .....   |
| 206482 | 14598 | Presser Foot Bracket Row Screw Washer, for 225699, 225930 and 225940 .....   |
| 206528 | 10925 | Presser Foot, for stitching margins $\frac{1}{8}$ , $\frac{1}{4}$ and $\frac{3}{8}$ in., for Machines Nos. 61w52 and 61w84 ..... |
| 206608 | 13375 | Presser Bar Lifting Releasing Lever Bracket Spring .....   |
| 206728 | 13363 | Bobbin Case Lever Driving Eccentric Connection with 244009, for 244020 .....   |
| 206730 | 13363 | Bobbin Case Lever Driving Eccentric Connection Lever with 200086c, for 244021 .....  |
| 206731 | 13363 | Bobbin Case Latch Fulcrum Pin, for 206736 .....  |
| 206733 | 13378 | Bobbin Case Cap with 200592c, 204046c and 206738, for 206734 .....   |
| 206734 | 13363 | Bobbin Case Cap complete, Nos. 200964c, 206733, 206736 and 240736, for 207058 .....  |
| 206735 | 13363 | Bobbin Case Latch, for 206736 .....  |
| 206736 | ---   | " " " " 206735 with 206731 and 206737, for 206734 .....  |
| 206737 | 13363 | Bobbin Case Latch Lever, for 206736 .....  |
| 206728 | 13363 | " " " " Tension Spring, for 206733 .....   |
| 206758 | ---   | Bobbin Case Lever Driving Eccentric Connection Lever Oil Wick, for 244020 .....  |
| 206761 | 13363 | Bobbin Case Lever Driving Eccentric Washer, for 244019 .....   |



| No.     | Plate | Name  |
|---------|-------|---|
| 206775  | 11671 | Hook Shaft Pin, for 244011 and 244023 .....   |
| 206785  | 10929 | Presser Foot .....  |
| 206786  | 10929 | " " (split), for Machines Nos. 61w52 and 61w84 .....  |
| 206787  | 13353 | Presser Foot, for stitching margins from $\frac{1}{2}$ to $\frac{1}{4}$ in., in steps of $\frac{1}{8}$ in., for Machines Nos. 61w52 and 61w84 .....                     |
| 206788  | 10929 | Presser Foot, for Machines Nos. 61w52 and 61w84 .....   |
| 206790  | 10927 | Presser Foot, for stitching margins $\frac{1}{2}$ to $\frac{1}{4}$ in., in steps of $\frac{1}{8}$ in., with 200904r and 202809, for Machines Nos. 61w52 and 61w84 ..... |
| 206791  | 10925 | Presser Foot, for use with English Binder, for Machines Nos. 61w52 and 61w84 .....  |
| 206792  | 10925 | Presser Foot, for stitching margins from $\frac{1}{2}$ to $\frac{1}{4}$ in., in steps of $\frac{1}{8}$ in., for Machines Nos. 61w52 and 61w84 .....                     |
| 206794  | 10929 | Presser Foot, for tailoring work, for Machines Nos. 61w52 and 61w84 .....   |
| 206840  | 11598 | Tuck Folder Screw Stud Adjusting Screw Spring Washer, for 225927 .....  |
| 206842  | 13356 | Presser Foot Cleft Holder, for Machines Nos. 61w52 and 61w84 .....  |
| 206852  | 13375 | Hook Gib, for 244011 and 244023 .....   |
| 206860  | -     | Feed Driving Rock Shaft 202303 with 200641C, 201522c, and 202375, for 203121 .....  |
| *206891 | -     | Needle Bar Connecting Stud, for 202329 .....  |
| 206974  | 11600 | Hemmer Foot, for $\frac{1}{2}$ in. hem, for Machines Nos. 61w52 and 61w72 .....   |
| 206975  | 13357 | Throat Plate, 50 needle hole, for needle sizes 14 and 15, with 202534, 202619 and two 200583n, for 203071 .....   |
| 206992  | 13380 | Presser Foot, for tack marking or creasing, for 244022 .....  |
| 206998  | 13356 | Presser Foot Holder with 200542a, for Presser Bar 202335 as a substitute for Compound Presser Bar 202514, for 225865 .....  |
| 207051  | 10915 | Feed Dog, for handkerchief hemming, knit goods and shoe lining, for 202819 .....  |

| No.     | Plate | Name   |
|---------|-------|--|
| 207052  | 10915 | Feed Dog, for handkerchief hemming, knit goods and shoe lining, for 202819 .....   |
| 207053  | 10915 | Feed Dog, for shirt, collar and cuff work, for 202817 .....  |
| 207054  | 10915 | Feed Dog, for shirt, collar and cuff work, for 202817 .....  |
| 207055  | 10915 | Feed Dog, for general muslin work, for 202818, 202951, 203073 and 203113 .....   |
| 207056  | 10915 | Feed Dog, for general muslin work, for 202818, 202951, 203073 and 203113 .....   |
| 207057  | 13363 | Bobbin Case Base, for 207058 .....   |
| 207058  | 13363 | Bobbin Case complete, Nos. 206734 and 207057, for 244021, 244022 and 244024 .....  |
| 207072  | 13375 | Presser Bar Bushing .....  |
| 207075  | 13380 | Feed Dog, for leather work, for 207076 .....   |
| 207076  | 13380 | Throat Plate, 50 needle hole, for needle sizes 14 and 15, with 202534, 202619 and two 200583n, for 207075 .....  |
| *207079 | -     | Arm, for Machines Nos. 61w52, 61w72 and 61w84 .....  |
| 207080  | 13376 | Arm Shaft Bushing (front) with 202244 .....  |
| *207081 | -     | Bed, for Machines Nos. 61w52, 61w72 and 61w84 .....  |
| 207082  | 13376 | Bed Plate (back), for Machines Nos. 61w52, 61w84 and 61w154 .....  |
| 207083  | 13376 | Bed Slide (front), for Machines Nos. 61w52, 61w72 and 61w84 .....  |
| *207084 | -     | Arm, for Machine No. 61w154 .....  |
| *207085 | -     | Bed, for Machine No. 61w154 .....  |
| 207086  | 13376 | " Slide (front), for Machine No. 61w154 .....  |
| 210736  | 13363 | Bobbin Case Latch Spring, for 206734 .....   |
| 213540  | 13380 | Ribbon Reel Center Pin Washer, for 226211 .....  |
| 225381  | 10884 | Bobbin Winder Spindle, for 225382 .....  |
| 225387  | 10885 | Universal Bobbin Winder complete, Nos. 200056c, 200082b, 200299n, 202473, 202478, 225381, 225433, 225444, 225453 to 225456, 225458, 225462, 228026, two each 225459 and wood screws $\frac{3}{8}$ in., No. 12, R.H.B. .... |

| No.     | Plate | Name  |
|---------|-------|---|
| 225433  | 10885 | Bobbin Winder and Tension Bracket Base, for 225382  |
| 225438  | 10884 | Bobbin Winder Frame Oil Well Cap, for 225453  |
| 225444  | 10884 | Bobbin Winder Stop Latch, for 225382  |
|         |       | Nos. 225453 to 225456, for 225382   |
| 225453  | 10884 | Bobbin Winder Frame with 202277 and 225438  |
| 225454  | 10884 | Bobbin Winder Frame Hinge Pin   |
| 225455  | 10884 | " " " Spring  |
| 225456  | 10884 | " " " Plunger   |
| 225458  | 10884 | " " " Stop Latch Thumb Lever, for 225382  |
| 225459  | 10884 | Bobbin Winder Stop Latch Thumb Lever Hinge Stud   |
| 225459  | 10884 | Bobbin Winder Stop Latch Thumb Lever Joint Stud, for 225382   |
| 225461  | 10881 | Bobbin Winder Tension Bracket with 201499a, for 225462  |
| 225462  | 10881 | Bobbin Winder Tension Bracket complete, Nos. 201572a, 202407, 225461 and two 2102, for 225382             |
| *225482 |       | Bobbin Case Screw Driver Blade, for 225497  |
| *225483 |       | Bobbin Case Screw Driver Handle, for 225497   |
| *225484 |       | Screw Driver Blade, for 225498  |
| *225485 |       | " " Handle, for 225498  |
| 225497  | 12153 | Bobbin Case Screw Driver complete, Nos. 225482 and 225483   |
| 225498  | 12153 | Screw Driver complete (7 1/2 in. long), Nos. 225484 and 225485, for Machines Nos. 61w52, 61w84 and 61w154 |
|         |       | Nos. 225502 to 225504, for Machines Nos. 61w52 and 61w84  |
| 225502  | 10354 | Hemmer Foot, for 3/4 in. hem  |
| 225503  | 10354 | " " " lace, for 3/4 in. hem   |
| 225504  | 10354 | Hemmer Foot, for 1/2 in. hem  |
| 225508  | 10923 | Presser Foot, for gathering, for Machines Nos. 61w52 and 61w84  |
| 225554  | 12153 | Wrench (creel), for Machines Nos. 61w52, 61w84 and 61w154   |
| 225586  | 11600 | Hemmer Shank Position Pin, for 225797   |

| No.    | Plate | Name   |
|--------|-------|--|
| 225610 | 1019  | Binder Bed, for 225612   |
| 225612 | 1019  | " Folder with 225610, for 225623   |
| 225613 | 1019  | " " Slide with 200768e, for 225623   |
| 225614 | 1019  | Binder Folder Slide Adjusting Thumb Nut Guide, for 226077  |
| 225615 | 1019  | Binder Folder Slide Cap, for 225623  |
| 225616 | 1019  | Guide (front), for 225623  |
|        |       | Nos. 225618 to 225620, for 225623  |
| 225618 | 1019  | Guide (back, lower)  |
| 225619 | 1019  | " (back, upper)  |
| 225620 | 1019  | Binder Pressure Spring   |
| 225621 | 1010  | Presser Foot, for Machines Nos. 61w52 and 61w84  |
| 225622 | 1010  | Throat Plate, 53 needle hole, for needle sizes 12 and 13, with 202534, 202619 and two 200582a, for 225977  |
| 225623 | 1010  | Binder complete, Nos. 200176b, 225612, 225613, 225615, 225616, 225618 to 225620, 226077, two each 200164a and 200893b, for Machines Nos. 61w52 and 61w84                           |
| 225624 | 1198  | Binder on Shank, for tapes 3/4, 7/8, 1, 1 1/8, 1 1/4, 1 1/2, 1 3/4, 1 7/8 and 1 in., for Machines Nos. 61w52 and 61w84   |
| 225630 | 1012  | Binder on Shank, for tapes from 1/2 to 1 in., in steps of 1/16 inch, for Machines Nos. 61w52 and 61w84   |
| 225631 | 1012  | Binder on Shank with Shank extending beyond Binder, for tapes of the following widths: 3/4, 7/8, 1, 1 1/8, 1 1/4, 1 1/2, 1 3/4, 1 7/8 and 1 in., for Machines Nos. 61w52 and 61w84 |
| 225633 | 1012  | Binder on Shank, in sizes 1/2 and 3/4 in., for Machines Nos. 61w52 and 61w84   |
| 225634 | 1012  | Binder on Shank, for 1/2, 3/4 and 1 in., for Machines Nos. 61w52 and 61w84   |
| 225646 | 1016  | Binder on Shank, for tapes from 1/2 to 1 in., in steps of 1/8 in., for Machines Nos. 61w52 and 61w84   |
| 225659 | 1016  | Bias Binder on Shank, for binding from 3/4 to 1 in., in steps of 1/8 in., for Machines Nos. 61w52 and 61w84  |
| 225663 | 321   | Ribbon Reel (9 in. diam.) with 225666, for 225976  |

| No.    | Plate | Name  |
|--------|-------|---|
| 225664 | 11598 | Ribbon Reel Supporting Spindle for 225665   |
| 225665 | ---   | Ribbon Reel Supporting Spindle Base with 225664 and two wood screws $\frac{3}{4}$ in., No. 7, for 225976 and 226291     |
| 225666 | ---   | Ribbon Reel Supporting Spindle Hub 230471 with 225980, for 225663 and 226290  |
| 225684 | 10322 | Corder Arm with 200340c, 201523b and three 225686, for 225688   |
| 225685 | 10322 | Corder Arm Bracket with 200851b, for 225688   |
| 225686 | 10322 | Corder Arm Cord Guide, for 225684   |
| 225687 | 10322 | " " Bracket Hinge Pin, for 225688   |
| 225688 | 11599 | Corder Arm and Bracket complete, Nos. 225684, 225685, 225687, 225689 and two 200035c, for Machines Nos. 61w52 and 61w84 |
| 225689 | 10322 | Corder Arm Bracket Screw Clamp Washer, for 225688   |
| 225690 | 10923 | Presser Foot, from 4 to 16 cords to the in., as ordered, for top and bottom cording, for Machines Nos. 61w52 and 61w84  |
| 225693 | 10325 | Presser Foot and Bracket, for 225699, 225930 and 225940   |
| 225695 | ---   | Presser Foot Bracket Bow, 8 in. long, with 225698 and 231149, for 225699  |
| 225696 | 10325 | Presser Foot Bracket Bow, 6 in. long, with 225698 and 231149, for 225930  |
| 225697 | ---   | Presser Foot Bracket Bow, 4 in. long, with 225698 and 231149, for 225940  |
| 225698 | 10325 | Presser Foot Bracket Bow Cord Tube, for 225695, 225696 and 225697   |
| 225699 | 10325 | Corder, 8 in. bow, complete, Nos. 225693, 225695, two each 200185d and 206482, for Machines Nos. 61w52 and 61w84        |
| 225702 | 13356 | Presser Foot, for Welts, for Machines Nos. 61w52 and 61w84  |
| 225706 | ---   | Hemmer Base Plate Position Pin, for 203075  |

| No.    | Plate | Name   |
|--------|-------|--|
| 225707 | 13379 | Tuck Marker Tuck Creaser Plate 225932 with 202115, 225931, 225933, 225934, two each 200142c and 200172n, for 241031              |
| 225708 | 10344 | Hemmer Base Plate Spring, for 230000   |
| 225723 | 10926 | Presser Foot, for Machine No. 61w84  |
| 225729 | 11598 | Folder, turn the upper edge under and the under edge over, for M, H, XH, XXH or XXXH Material, for Machines Nos. 61w52 and 61w84 |
| 225734 | 10335 | Hemmer Swing Bracket Base Screw Stud Washer, for 226977  |
| 225735 | 10335 | Hemmer Swing Bracket Base, for 226977  |
| 225749 | 10393 | Hemmer Foot, for $\frac{1}{2}$ in. hem, for Machines Nos. 61w52 and 61w84  |
| 225764 | ---   | Hemmer on Shank, for 225769  |
| 225765 | 10344 | " Shank Switch Handle with 200397c and 201609, for 225769  |
| 225767 | ---   | Hemmer Plate with 200857c and 225586, for 225769   |
| 225769 | 10324 | Hemmer complete, for hems $\frac{1}{2}$ to 1 in., Nos. 201904, 225764, 225765, 225767 and 230000                                 |
| 225776 | 10346 | Hemmer, for $\frac{3}{4}$ in. hem, for 225778  |
| 225777 | 10346 | " Shank, for 225778  |
| 225778 | 10346 | Hemmer complete, Nos. 200142c, 202603, 225776 and 225777   |
| 225779 | 10347 | Hemmer on Shank, for $\frac{5}{8}$ in. hem, for 225781   |
| 225780 | 10347 | Hemmer Lace Guide, for 225781  |
| 225781 | 10347 | Hemmer (reverse) complete, Nos. 225779, 225780, two each 200142c and 202603  |
| 225787 | 11599 | Hemmer on Shank, for 230865  |
|        |       | Nos. 225790 to 225792, for 225793  |
| 225799 | 10350 | Hemmer on Shank  |
| 225791 | 10350 | " Base Plate with 200838c  |
| 225792 | 10350 | Presser Foot   |
| 225793 | 10350 | Hemmer complete, for hems $\frac{1}{2}$ to 1 in., Nos. 201557b and 225799 to 225792  |
| 225794 | ---   | Hemmer on Shank, for 225796  |
| 225796 | 10324 | Hemmer complete, for hems $\frac{1}{2}$ to $\frac{3}{4}$ in., Nos. 225794 and 230000   |

| No.  | Plate | Name   |
|--|-------|--|
| 225798   | 10353 | Presser Foot, for Machines Nos. 61w52 and 61w84 .....  |
| Nos. 225800 to 225817, for Machines Nos. 61w52 and 61w84 |       |  |
| 225800   | 10354 | Hemmer Foot, for lace, for $\frac{1}{8}$ in. hem .....   |
| 225801   | 10393 | Hemmer Foot, for $\frac{1}{4}$ in. hem, for thick soft woolsens and felling corset seams .....   |
| 225802   | 10393 | Hemmer Foot, for $\frac{3}{8}$ and $\frac{1}{2}$ in. hem, for cord guiding, sews a cord within the hem .....   |
| 225803   | 10353 | Hemmer on Shank, for hems of the following widths: $\frac{1}{8}$ , $\frac{3}{16}$ , $\frac{1}{4}$ , $\frac{5}{16}$ , $\frac{3}{8}$ and $\frac{1}{2}$ inch .....    |
| 225804   | 10353 | Hemmer on Shank, for hems of the following widths: $\frac{5}{16}$ , $\frac{3}{8}$ , $\frac{1}{2}$ , $\frac{5}{8}$ , $\frac{3}{4}$ , $\frac{7}{8}$ and 1 inch ..... |
| 225805   | 10354 | Hemmer Foot, for lace, for $\frac{1}{4}$ in. hem .....   |
| 225806   | 10354 | Hemmer Foot, for $\frac{3}{8}$ in. hem .....   |
| 225807   | 10355 | " " for $\frac{1}{8}$ in. hem .....  |
| 225808   | 10355 | " " $\frac{1}{4}$ in. hem, for felling .....   |
| 225809   | 10355 | " " $\frac{1}{4}$ in. hem .....  |
| 225810   | 10355 | " " $\frac{3}{8}$ in. hem .....  |
| 225811   | 10355 | " " $\frac{1}{2}$ in. hem .....  |
| 225812   | 10355 | " " $\frac{3}{8}$ in. hem, for "L" shaped Feed Dog 202283 only ..  |
| 225813   | 10355 | Hemmer, for $\frac{1}{8}$ in. hem (Troy, long)   |
| 225814   | 10355 | " " $\frac{1}{4}$ in. hem (Troy short)   |
| 225815   | 10355 | " " $\frac{3}{8}$ in. hem .....  |
| 225816   | 10355 | " " $\frac{1}{2}$ in. hem .....  |
| 225817   | 10355 | " " $\frac{3}{8}$ in. hem .....  |
| Nos. 225827 to 225829, for 225842                        |       |  |
| 225827   | 10357 | Plaiter Base Plate .....   |
| 225828   | 10357 | " " " " Arm Bracket with two 200383c .....   |
| 225829   | 10358 | Plaiter Base Plate Arm Shaft .....   |
| 225830   | 10358 | " " Folder Guide, for 225919 .....   |
| 225831   | 10358 | " " Bracket, for 225919 .....  |
| 225833   | 10358 | " " " " Stop Spring, for 225919 .....  |
| 225835   | 10358 | Plaiter Guide, for 225842 .....  |
| 225836   | 10358 | " " Adjustable Stop, for 225842 .....  |

| No.                               | Plate | Name  |
|-----------------------------------|-------|---|
| 225839                            | 10358 | Plaiter Space Guide, for 225841 ..  |
| 225840                            | 10358 | " " " " Bracket, for 225841 .....   |
| 225841                            |       | Plaiter Space Guide complete, Nos. 200417a, 200462b, 201531c, 225839, 225840 and two 200110c, for 225842 .....  |
| 225842                            | 10321 | Plaiter complete, Nos. 200169c, 200651c, 200845c, 225827 to 225829, 225835, 225836, 225841, 225909, 225919, 226163, two 226164 and three 200579c, for 225919 .....          |
| Nos. 225843 to 225845, for 225857 |       |   |
| 225843                            | 10360 | Ruffler Driving Lever .....   |
| 225844                            | 10360 | " " " " Spring .....  |
| 225845                            | 10360 | " " Frame with 225959 .....   |
| 225846                            | 10361 | " " Guide (left) with 225856 and two 200178b, for Machines Nos. 61w52 and 61w84 .....   |
| 225847                            | 10361 | Ruffler Guide (right) with 225856 and two 200178b, for Machines Nos. 61w52 and 61w84 .....  |
| 225848                            | 10360 | Ruffler Needle Bar Collar (for driving 225843), for 225859 .....  |
| 225849                            | 10360 | Ruffler Needle Bar Collar complete, Nos. 200615c, 201856 and 225848, for 225857 .....   |
| 225851                            | 10360 | Ruffler Ruffling Blade, for 225857 ..   |
| 225852                            | 10360 | " " " " Clamp, for 225853 .....   |
| 225853                            | 10360 | Ruffler Ruffling Blade Lever with 225852, 225854 and two 200175b, for 225857 .....  |
| 225854                            | 10360 | Ruffler Ruffling Blade Lever Adjusting Thumb Screw Bushing, for 225853 .....  |
| 225855                            | 10360 | Ruffler Ruffling Blade Switching Lever, for 225857 .....  |
| 225856                            | 10361 | Ruffler Ruffling Separating Blade, for 225846 and 225847 .....  |
| 225857                            | 10361 | Ruffler complete, Nos. 200126b, 200255c, 200310c, 200465c, 201554c, 201583c, 225843 to 225845, 225850, 225851, 225853 and 225855, for Machines Nos. 61w52 and 61w84 ..      |
| 225862                            | 10356 | Presser Foot, for stitching margins from $\frac{1}{8}$ to $\frac{1}{4}$ in., in steps of $\frac{1}{16}$ in., for collar and cuff work, for Machines Nos. 61w52 and 61w84 .. |

## Numerical List of Parts

| No.    | Plate | Name   |
|--------|-------|--|
| 225865 | 10355 | Presser Foot Cleft Holder, for use with 206998, for interchangeable Pressers and Hammers, for Machines Nos. 61w52 and 61w84 . . . . .  |
| 225896 | 13379 | Tuck Marker Shaft Driving Crank Cap, for 225939 . . . . .  |
| 225909 | 10358 | Plaiter Folder Bracket Guide Stop with 200382c, for 225842 . . . . .   |
| 225919 | -     | Plaiter Folder Bracket 225831 with 225839, 225833, two each 200110c and 200137c, for 225842 . . . . .  |
| 225923 | 10321 | Tuck Folder, for 225927 . . . . .  |
| 225924 | 10321 | " " Arm, for 225927 . . . . .  |
| 225926 | 10321 | " " Space Gauge, for 225927 . . . . .  |
| 225927 | 10321 | Tuck Folder complete, Nos. 200090c, 200318a, 200836c, 200843c, 201562c, 201564c, 202600, 202603, 20640, 225923, 225924 and 225926, for Machines Nos. 61w52 and 61w84 . . . . . |
| 225930 | 10325 | Corder, 6 in. low, complete, Nos. 225693, 225696, two each 200139c and 206482, for Machines Nos. 61w52 and 61w84 . . . . .   |
|        |       | Nos. 225931 to 225934, for 225707 . . . . .  |
| 225931 | 10381 | Tuck Marker Tuck Creaser . . . . .   |
| 225932 | -     | " " " " " " Plate . . . . .  |
| 225933 | 10381 | " " " " " " Slide . . . . .  |
| 225934 | 10381 | " " " " " " Spring . . . . .   |
|        |       | Nos. 225935 to 225937, for 214031 . . . . .  |
| 225935 | 10381 | Tuck Marker . . . . .  |
| 225936 | 13379 | " " Shaft with 200175d . . . . .   |
| 225937 | 13379 | " " Bracket with two 200579e . . . . .   |
| 225939 | 13379 | Tuck Marker Shaft Driving Crank complete, Nos. 200047c, 225896 and 225945, for 214031 . . . . .  |
| 225940 | 10325 | Corder, 4 in. low, complete, Nos. 225693, 225697, two each 200183a and 206482 . . . . .  |
| 225941 | 13379 | Tuck Marker Shaft Rock Lever, for 225997 . . . . .   |
| 225942 | 10381 | Tuck Marker Shaft Rock Lever Pinch Screw Handle with 200852c, for 225997 . . . . .   |

## Numerical List of Parts

| No.    | Plate | Name  |
|--------|-------|---|
| 225943 | 10381 | Tuck Marker Shaft Stop Collar with 200481a, for 214031 . . . . .  |
| 225945 | -     | Tuck Marker Shaft Driving Crank with 201813, for 225939 . . . . .   |
| 225949 | 13356 | Presser Foot, for Welts, for Machines Nos. 61w52 and 61w84 . . . . .  |
| 225959 | 10360 | Ruffler Ruffing Blade Switching Lever Stop Pin, for 225842 . . . . .  |
| 225962 | 10511 | Folder on Shank, folds the top goods under and the under goods over and guides a piece of goods between them from the left, for Machines Nos. 61w52 and 61w84 . . . . .             |
| 225970 | 11600 | Hemmer on Shank, made for hems of the following widths: $\frac{1}{4}$ , $\frac{3}{8}$ , $\frac{1}{2}$ , $\frac{5}{8}$ , $\frac{3}{4}$ , and $\frac{7}{8}$ in., for 225973 . . . . . |
| 225973 | -     | Hemmer on Swing Bracket complete, Nos. 225970 and 226977, for Machines Nos. 61w52 and 61w84 . . . . .   |
| 225976 | -     | Ribbon Reel (9 in. diam.) complete, Nos. 225663 and 225665 . . . . .  |
| 225977 | 10310 | Feed Dog, for 225622 . . . . .  |
| 225980 | -     | Ribbon Reel Supporting Spindle Hub Base, for 225666 . . . . .   |
| 225997 | -     | Tuck Marker Shaft Rock Lever 225941 with 225942, for 214031 . . . . .   |
| 225998 | 10309 | Folder Slide Adjusting Thumb Nut Sleeve Screw Center, for 226112 . . . . .  |
| 226000 | 13357 | Throat Plate, 53 needle hole, for needle sizes 12 and 13, with 202534, 202619 and two 200583b, for top and bottom cording, for 203173 . . . . .                                     |
| 226029 | 10923 | Presser Foot, for darning, for Machines Nos. 61w52 and 61w84 . . . . .  |
| 226071 | 10335 | Hemmer Swing Bracket Base Hinge Screw Spring Washer, for 226977 . . . . .   |
| 226077 | -     | Folder Slide Adjusting Thumb Nut Guide with 225614 with 226112, for 225622 . . . . .  |
| 226110 | 11599 | Hemmer Swing Bracket with 200369b and 200862c, for 226977 . . . . .   |
| 226112 | 10309 | Folder Slide Adjusting Thumb Nut Sleeve with 225998, for 226077 . . . . .   |
| 226163 | 10359 | Plaiter Guide Screw Stud Washer, for 225842 . . . . .   |
| 226164 | 10359 | Plaiter Folder Bracket Stop Collar with 200113c, for 225842 . . . . .   |

## Numerical List of Parts

| No.    | Plate | Name  |
|--------|-------|---|
| 226164 | 10359 | Plaiter Space Guide Bracket Stop Collar with 200413c, for 228342  |
| 226165 | 10923 | Presser Folder, for folding a 2 in. fold from the left which is to be stitched near the edge, for Machines Nos. 61w52 and 61w84 |
| 226200 | -     | Ribbon Reel (6 in. diam.) with 225666   |
| 226201 | -     | Ribbon Reel (6 in. diam.) complete, Nos. 225665 and 226200  |
| 226211 | -     | Ribbon Reel (holding projection 6 in. diam.) with 213540 and 226211   |
| 226212 | 11598 | Ribbon Reel Center Pin, for 226211  |
| 226663 | 11690 | Hemmer Adjusting Screw Washer for Machines Nos. 61w52 and 61w84   |
| 226663 | 11690 | Hemmer Plate Clamp Washer, for 230000   |
| 226977 | -     | Hemmer Swing Bracket 226410 with 200457a, 2015261, 201563b, 225734, 225735 and 226074, for 225973                               |
| 228026 | 10884 | Bobbin Winder Tension Bracket Screw Washer, for 225382  |
| 228043 | 11690 | Hemmer Adjusting Thumb Screw Washer, for 230865   |
| 228170 | -     | Drip Pan  |
| 228212 | -     | " " (short) with four 1 in. wire nails, for Machines Nos. 61w52, 61w72 and 61w84  |
| 228213 | -     | Drip Pan (long) with four 1 in. wire nails, for Machine No. 61w154  |
| 228238 | 14171 | Knee Lifter Rock Shaft Lifting Lever with 356c, for 228239  |
| 228239 | -     | Knee Lifter Rock Shaft Lifting Lever 228238 with 8073, 204225, 228240 and 228241, for 228242 and 228243                         |
| 228240 | 14171 | Knee Lifter Rock Shaft Lifting Lever Rod (3 in. long), for 228239   |
| 228241 | 14171 | Knee Lifter Rock Shaft Lifting Lever Rod Swivel with 200529c, for 228239  |
| 228242 | 14171 | Knee Lifter Rock Shaft complete, Nos. 2763, 2768, 7539, 20092, 228239 and two 2770, for Machines Nos. 61w52, 61w72 and 61w84    |

## Numerical List of Parts

| No.    | Plate | Name  |
|--------|-------|---|
| 228243 | 14107 | Knee Lifter Rock Shaft complete, Nos. 2763, 7539, 20092, 228239, 228255, 228563, Form A 1079 and two 2770, for Machine No. 61w154                                 |
| 228255 | 14107 | Knee Lifter Rock Shaft Knee Plate Counterbalance Spring, for 228243   |
| 228562 | 14107 | Knee Lifter Rock Shaft Knee Arm, for 228563   |
| 228563 | -     | Knee Lifter Rock Shaft Knee Arm complete, Nos. 1507b, 2766, 2767 and 228562, for 228243   |
| 229000 | 13380 | Tape Tension Pin, for 230746  |
| 229055 | -     | Presser Foot Plate, for 202351  |
| 229597 | 10925 | Presser Foot, stitching margins from $\frac{1}{8}$ to $\frac{3}{8}$ in., in steps of $\frac{1}{16}$ in., for open bosom shirts, for Machines Nos. 61w52 and 61w84 |
| 229843 | 11690 | Hemmer Foot, for $\frac{3}{8}$ and $\frac{5}{8}$ in. hem, for cord guiding, sews a cord within the hem, for Machine No. 61w84                                     |
|        |       | No. 229856 to 229858, for Machines Nos. 61w52 and 61w84   |
| 229856 | 10929 | Presser Foot  |
| 229857 | 10929 | " "   |
| 229858 | 10929 | " "   |
| 229863 | 10927 | Presser Foot (hinged) complete, Nos. 202090, 202924 and 203010, for overalls and tailoring, for Machines Nos. 61w52 and 61w84                                     |
| 229864 | 10927 | Presser Foot (hinged) complete, Nos. 202090, 202924 and 203009, for Machines Nos. 61w52 and 61w84   |
| 229865 | 10927 | Presser Foot (hinged) complete, Nos. 202090, 202924 and 203024, for tailoring, for Machines Nos. 61w52 and 61w84  |
| 229867 | 10927 | Presser Foot (hinged) complete, Nos. 202090, 202924 and 203011, for overalls, for Machines Nos. 61w52 and 61w84   |
| 229868 | 10927 | Presser Foot (hinged) complete, Nos. 202090, 202924 and 203012, for Machines Nos. 61w52 and 61w84   |

| No.    | Plate | Name  |
|--------|-------|---|
| 229871 | 10925 | Presser Foot (right hand spring guide), stitching margins from $\frac{1}{8}$ to $\frac{1}{4}$ in. in steps of $\frac{1}{16}$ in., with 200175n and 202897. Order margin required. For Machines Nos. 61w52 and 61w84 ..... |
| 230000 | 11599 | Hemmer Base Plate 203075 with 200246n, 201525n, 225708, 226663 and two 200160n, for 225769, 225796 and 230865 .....   |
| 230471 |       | Ribbon Reel Supporting Spindle Hub .....  |
| 230625 | 13354 | Feed Dog, for 230749, 230751 and 230833 .....   |
|        |       | Nos. 230744 to 230746, for 230751   |
| 230744 | 11650 | Cord Guide and Strip Folder .....   |
| 230745 | 11650 | Presser Foot, for cord covering ..  |
| 230746 | 11650 | Cord Covering Tape Tension Frame with six 229000 .....  |
| 230749 | 11650 | Throat Plate, 50 needle hole, for needle sizes 11 and 15, with 201566n, 202531 and two 200583n, for 230625 and 230751, for Machines Nos. 61w52 and 61w84 ..   |
| 230751 |       | Cord Covering Attachment complete, Nos. 25983, 200137n, 230625, 230744 to 230746 and 230749, for Machines Nos. 61w52 and 61w84 ..   |
| 230833 | 13357 | Throat Plate, 50 needle hole, for needle sizes 11 and 15, with 201566n, 202531 and two 200583n, used with Cord Covering Attachment, for 230625 .....  |
| 230864 | 11599 | Hemmer Plate, for 230865 .....  |
| 230865 |       | Hemmer complete, Nos. 200160n, 225787, 228013, 230000 and 230861, for Machines Nos. 61w52 and 61w84 .....   |
| 230930 | 13376 | Bed Plate (back), for 244011 .....  |
| 231149 |       | Presser Foot Bracket Bow Cord Tube (short), for 225695 to 225697 ..   |
| 231168 | 10355 | Hemmer, for $\frac{1}{4}$ in. hem, for Machines Nos. 61w52 and 61w84 ..   |
|        |       | Nos. 231235 to 231237, for 202037   |
| 231235 |       | Presser Foot Strip Guide with 200188c .....   |
| 231236 |       | Presser Foot Strip Guide Bar .....  |
| 231237 |       | " " " " " " Plate .....   |

| No.     | Plate | Name   |
|---------|-------|--|
| 231238  | 12355 | Presser Foot (hinged) (adjustable) complete, for strips $\frac{1}{8}$ to $\frac{1}{4}$ in., Nos. 202572, 202924 and 203037, for stitching shoe facings, for Machines Nos. 61w52 and 61w84 .. |
| 231337  | 13350 | Cloth Guide .....  |
| 236073  | 13375 | Needle Bar Connecting Link Oil Guard .....   |
| 237837  | 13377 | Knee Lifter Connection Lever, for 244035 and 244037 .....  |
| 244004  | 13375 | Presser Bar Lifting Releasing Lever Bracket .....  |
| 244007  | 10247 | Tension Disc (back), for 202409 ..   |
| 244008  | 10247 | " " (front), for 202409 ..   |
| 244009  |       | Bobbin Case Lever Driving Eccentric Connection Oil Packing (wick), for 206728 .....  |
| *244010 |       | Hook (sewing), for 244023 .....  |
| 244011  | 13377 | Hook 244010 with 200145c, 200596r, 200614c, 202320, 203101, 206775, 206852 and 244014, for 244012 and 244022 .....   |
| 244012  |       | Hook and Bobbin Case complete, Nos. 202533 and 244011, for Machines Nos. 61w52 and 61w72 ..  |
| 244013  | 13375 | Hook Counter Balance with 200444c, for Machines Nos. 61w52 and 61w72 .....   |
| 244014  | 13375 | Hook Washer, for 244011 and 244023 ..  |
| 244018  | 13378 | Bobbin Case Lever Driving Eccentric with 200380c and 200444c, for 244019 .....   |
| 244019  |       | Bobbin Case Lever Driving Eccentric 244018 with 200583n and 206761, for 244020 .....   |
| 244020  |       | Bobbin Case Lever Driving Eccentric Connection 206728 with 201194c, 201524c, 206758 and 244019, for 244021 .....   |
| 244021  |       | Bobbin Case Outfit complete, Nos. 200333c, 202500, 202501, 206730, 207058 and 244020, for Machines Nos. 61w84 and 61w154 .....   |
| 244022  |       | Hook and Bobbin Case complete, Nos. 207058 and 244011, for Machine No. 61w84 .....   |
| 244023  | 13377 | Hook 244010 with 200145c, 200596r, 200614c, 202319, 203101, 206775, 206852 and 244014, for 244024 ..   |

| No.    | Plate | Name  |
|--------|-------|---|
| 244024 | ----- | Hook and Bobbin Case complete, Nos. 207058 and 244023, for Machine No. 61w154 .....                                     |
| 244026 | 13380 | Throat Plate Bobbin Case Stop Position Pin, for 202811 .....  |
| 244027 | 13379 | Tuck Marker Guide, for 244028 ...   |
| 244028 | ----- | " " " 244027 with 200179b and 244029, for 244031 ...  |
| 244029 | 13379 | Tuck Marker Guide Tuck Smoothing Spring, for 244028 .....   |
| 244030 | 13379 | Tuck Marker Shaft Bracket Base Plate, for 244031 .....  |
| 244031 | ----- | Tuck Marker with 200469a, 225707, 225935 to 225937, 225939, 225997, 244028, 244030 and two 225943, for 244032 .....     |
| 244032 | ----- | Tuck Marker complete, Nos. 202294, 202830, 203177, 203187, 206992 and 244031, for Machine No. 61w72 ...                 |
| 244033 | ----- | Presser Bar (hollow), for 202235 ...  |
| 244034 | 13377 | Knee Lifter Lifting Lever, for 244035 .....   |
| 244035 | ----- | Knee Lifter Connection Lever 237837 with 202447, 244034 and two 200262a, for Machines Nos. 61w52, 61w72 and 61w81 ..... |
| 244036 | 13377 | Knee Lifter Lifting Lever, for 244037 .....   |
| 244037 | ----- | Knee Lifter Connection Lever 237837 with 202447, 244036 and two 200262a, for Machine No. 61w154 .....                   |
| 244041 | ----- | Adjustable Bench Tuck Folder complete, Nos. 36388, 36394, 202293, 202827, 203198 to 203200, 230930 and two 402b .....   |



**ILLUSTRATIONS OF PARTS  
FOR  
MACHINES  
Nos. 61w52, 61w72, 61w84  
and 61w154**

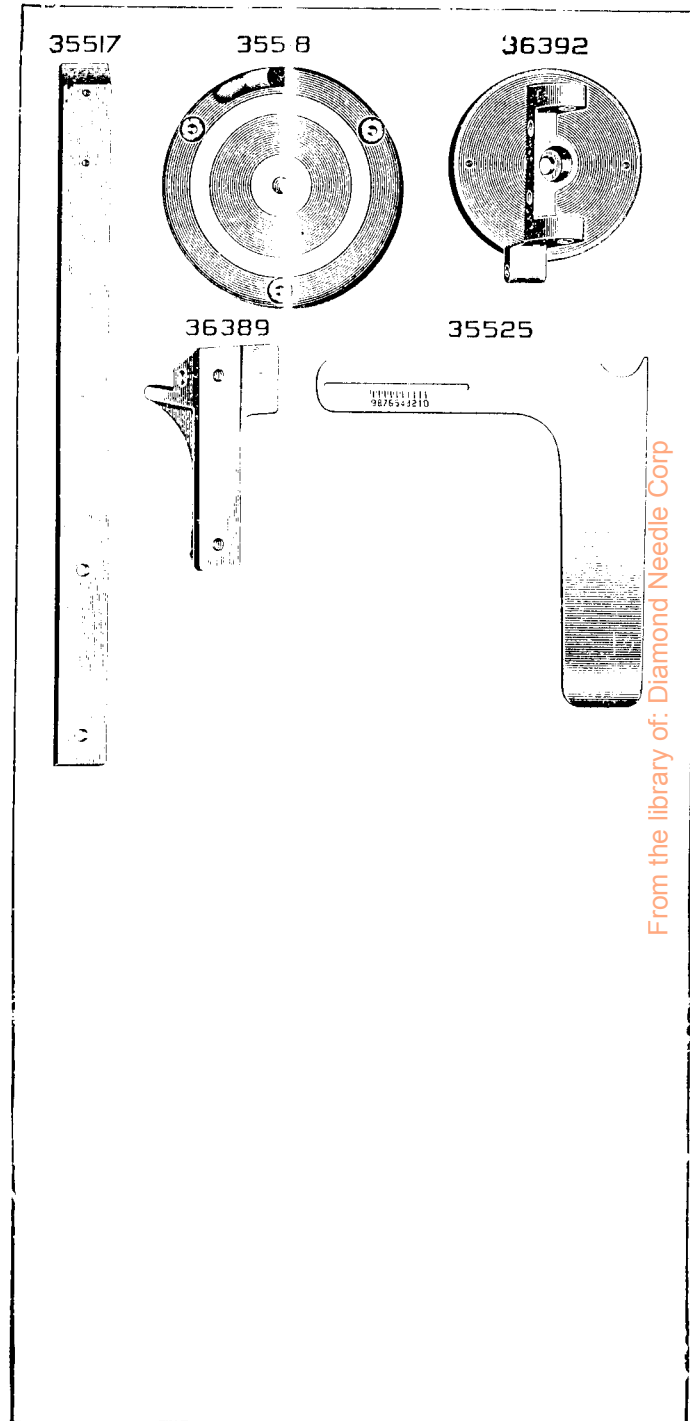


PLATE 5884—ONE-HALF SIZE

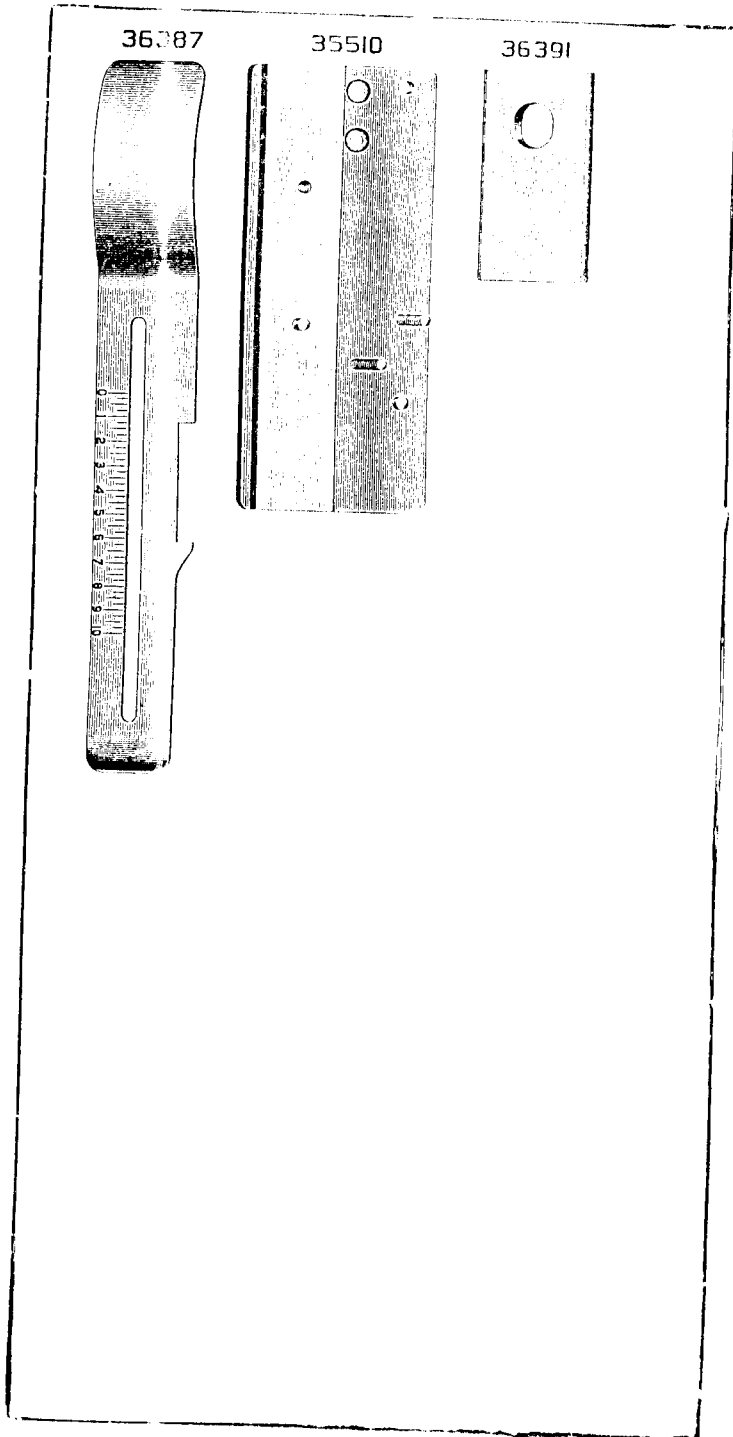
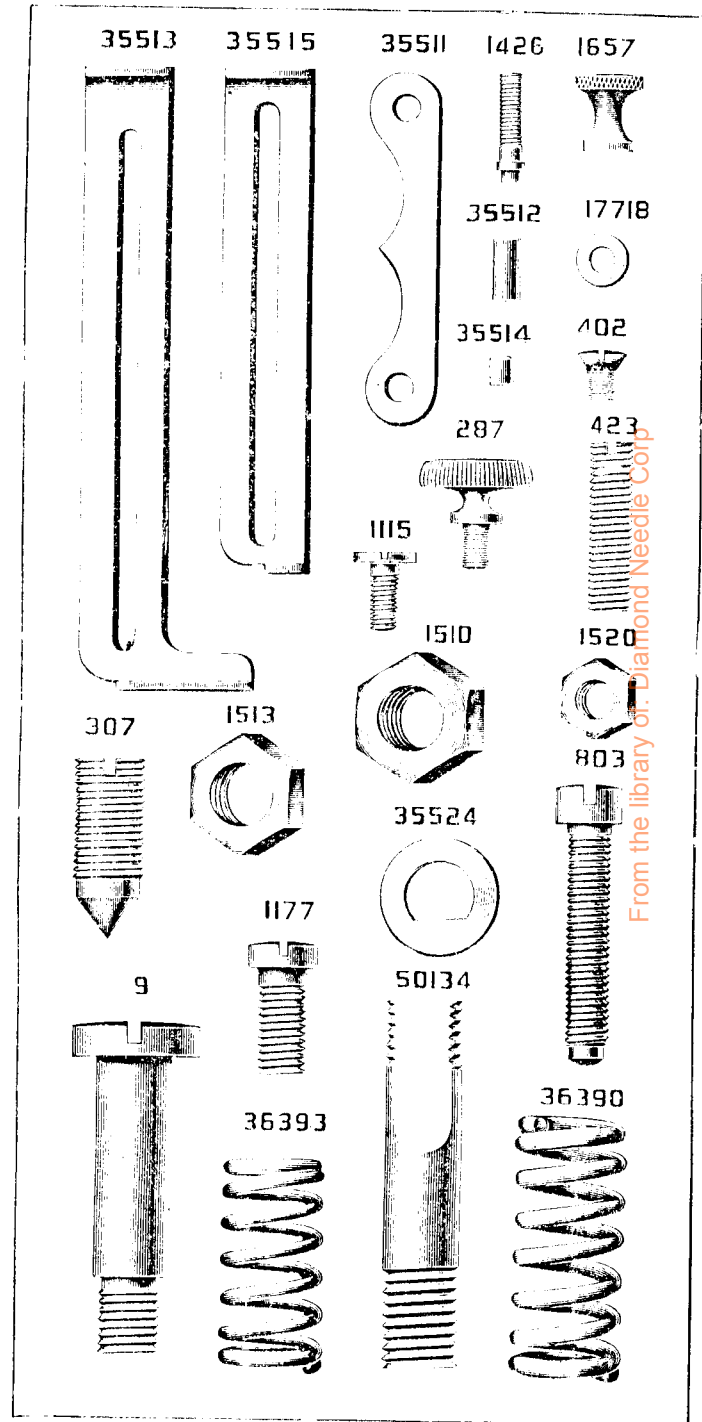


PLATE 5885—FULL SIZE



From the library of Diamond Needle Corp

PLATE 10244-FULL SIZE

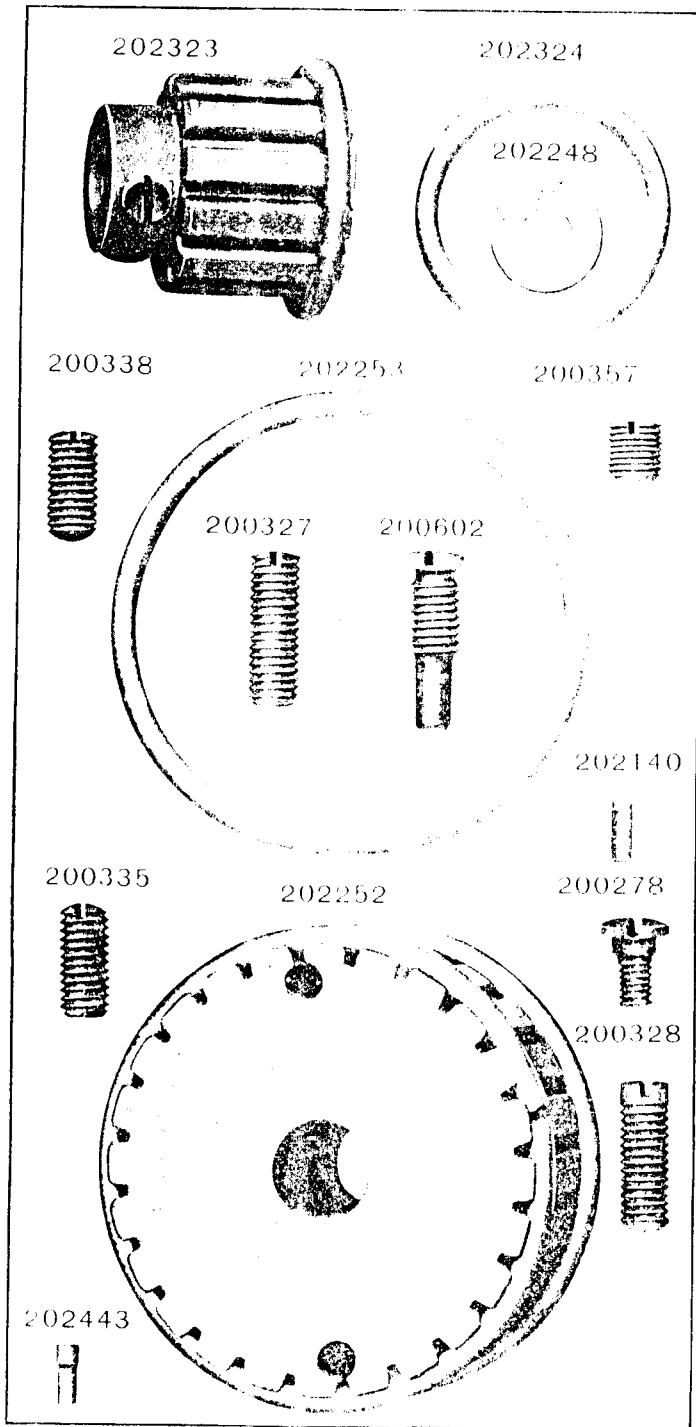
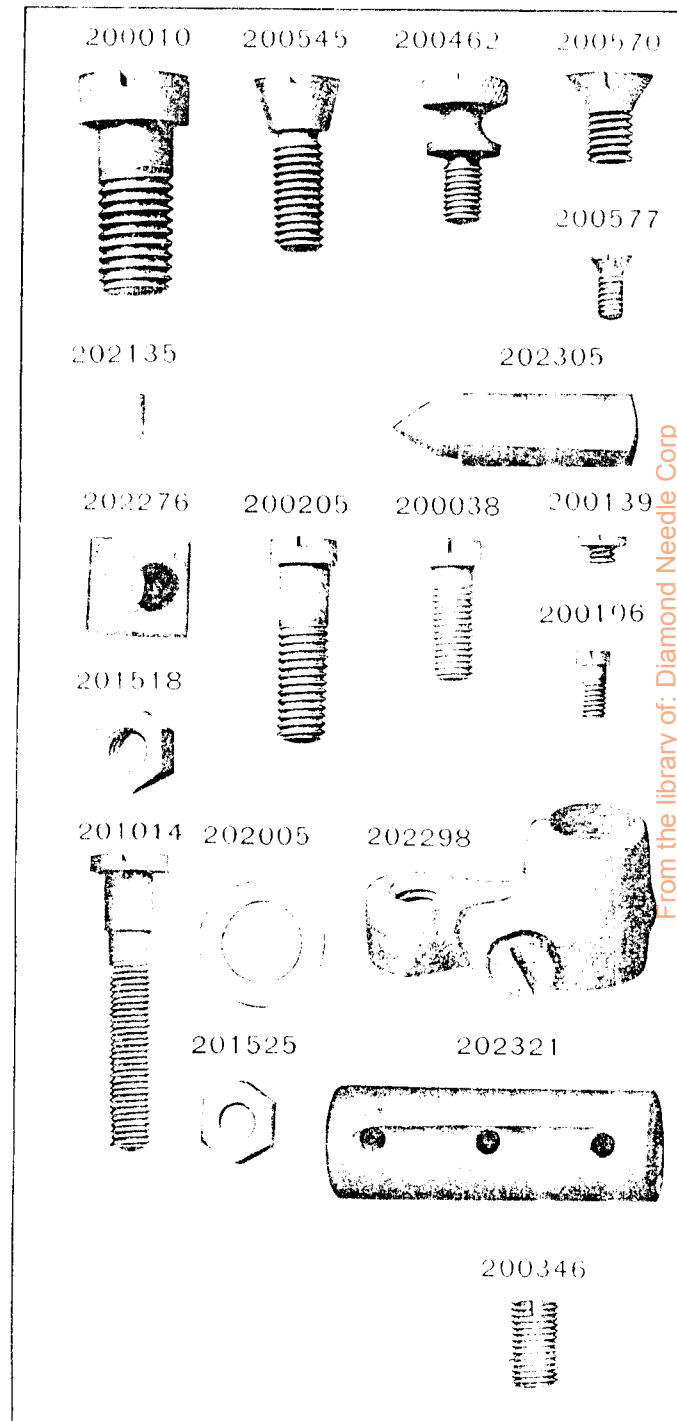


PLATE 10245-FULL SIZE



From the library of: Diamond Needle Corp

PLATE 10246-FULL SIZE

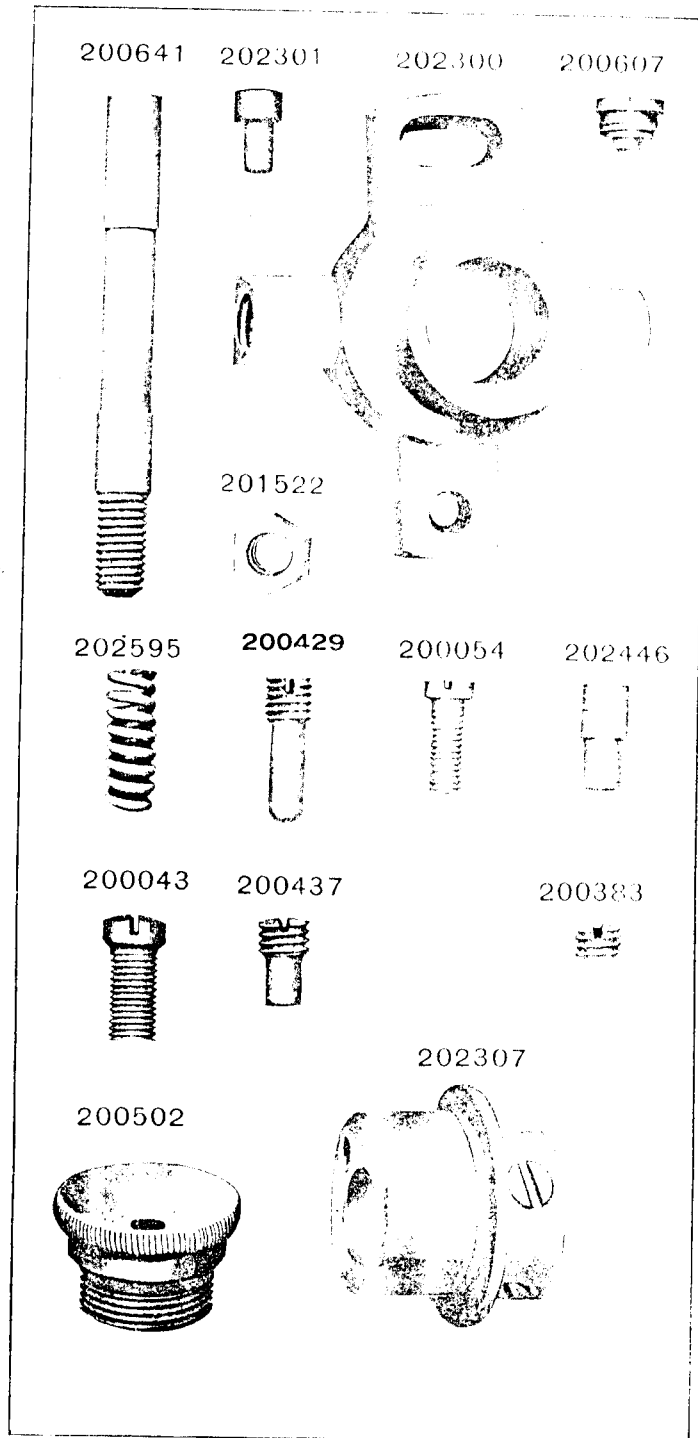
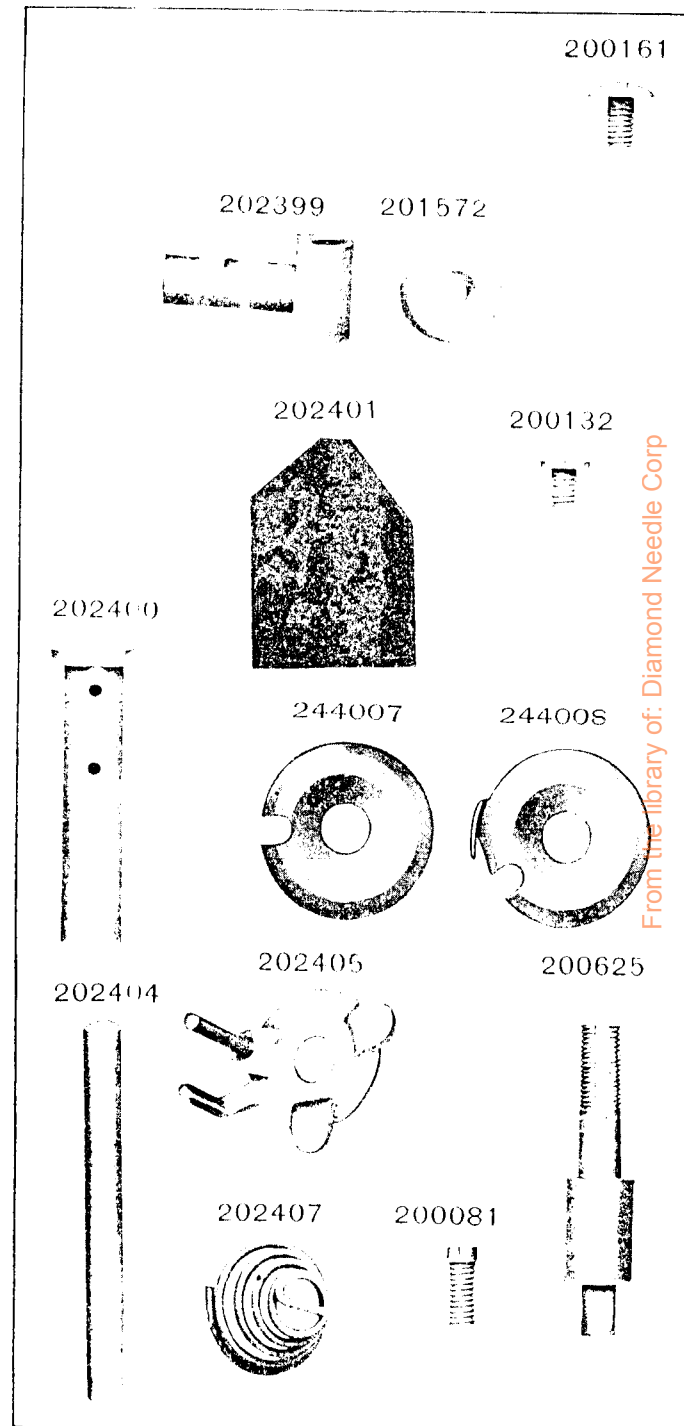


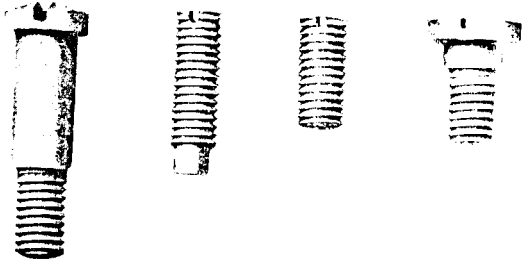
PLATE 10247-FULL SIZE



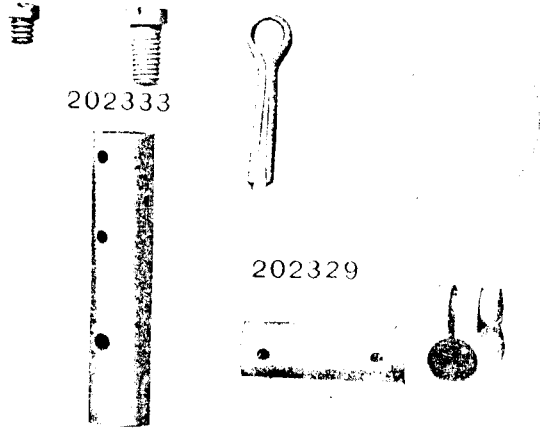
From the library of: Diamond Needle Corp

PLATE 10248—FULL SIZE

200224 200428 200335 200262



200141 200086 202302 203172



202333

202329

200352

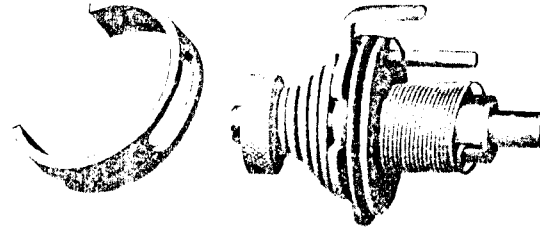


200363

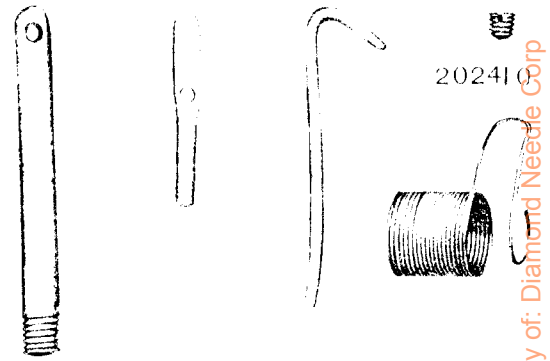


PLATE 10252—FULL SIZE

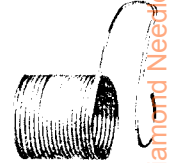
202411 202409



202412 202413 202414 200389



202410



204058 200582 202415



200355 202091 200366 202092



From the library of: Diamond Needle Corp

PLATE 10259—FULL SIZE

202368



202368



202369



202369



202370



202370



PLATE 10263—FULL SIZE

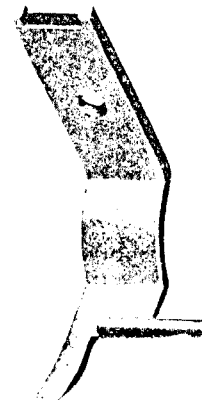
202390



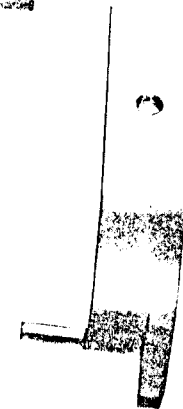
202390



202356



202356



From the library of: Diamond Needle Corp

PLATE 10309—FULL SIZE

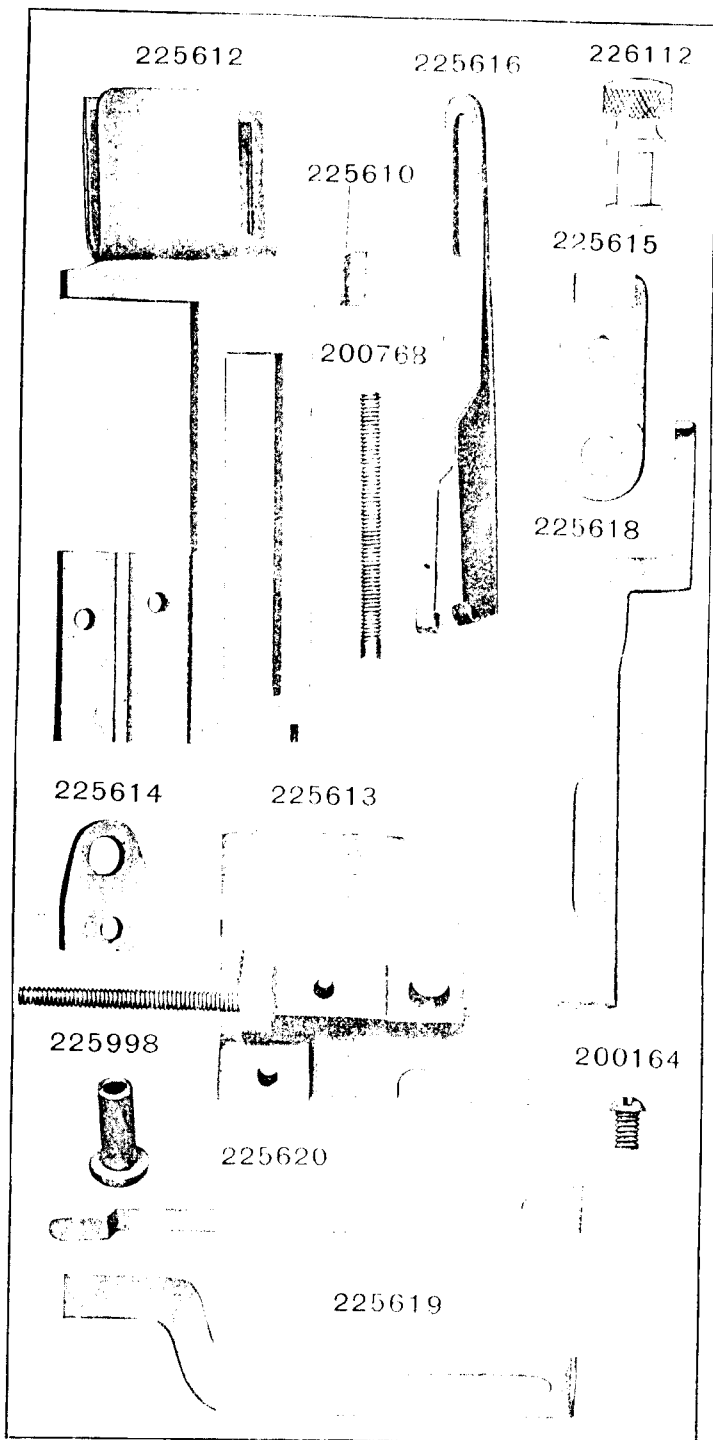
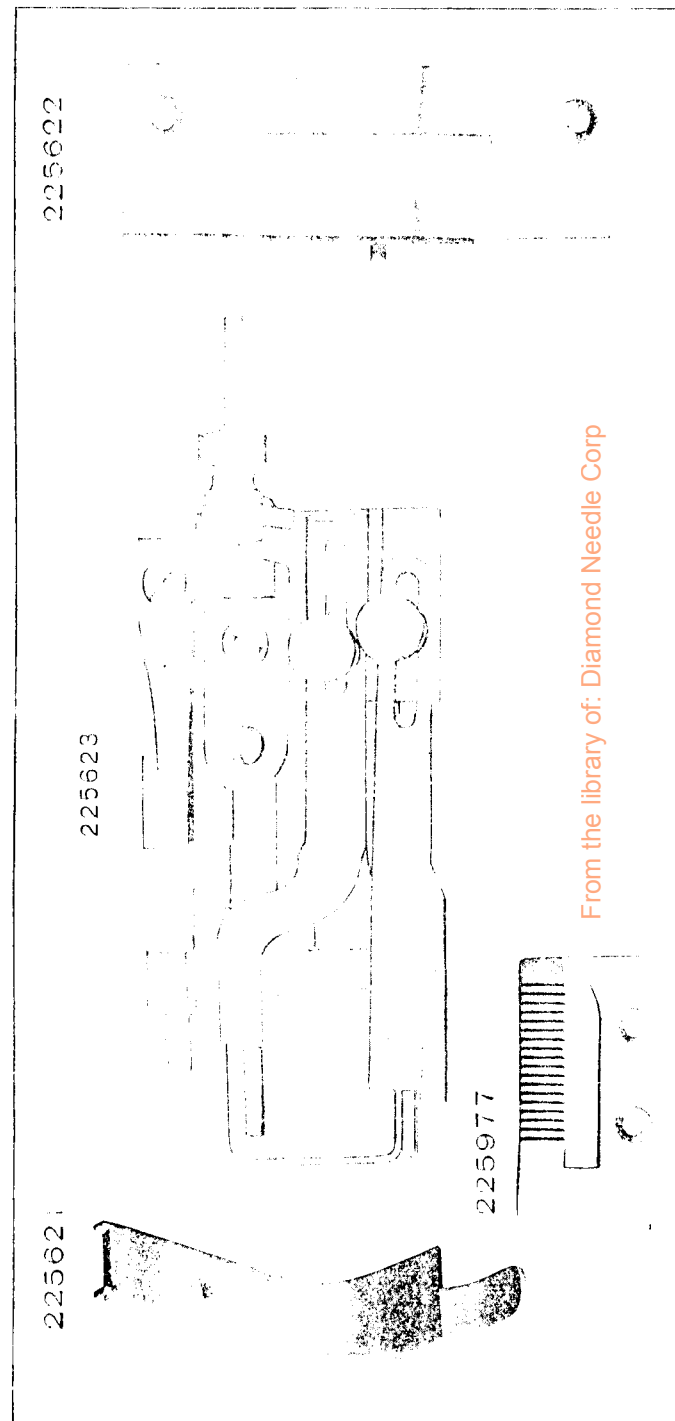


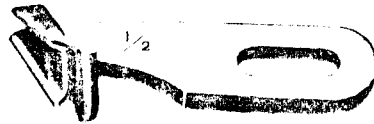
PLATE 10310—FULL SIZE



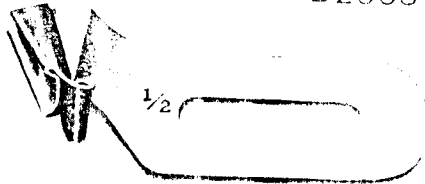
From the library of: Diamond Needle Corp

PLATE 10312—FULL SIZE

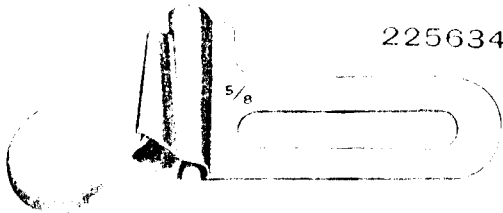
225630



225631



225634



202813



225633

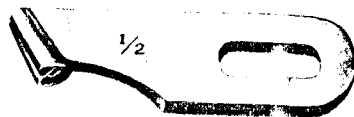


PLATE 10316—FULL SIZE

225659



From the library of: Diamond Needle Corp



PLATE 10321—ONE-FOURTH SIZE

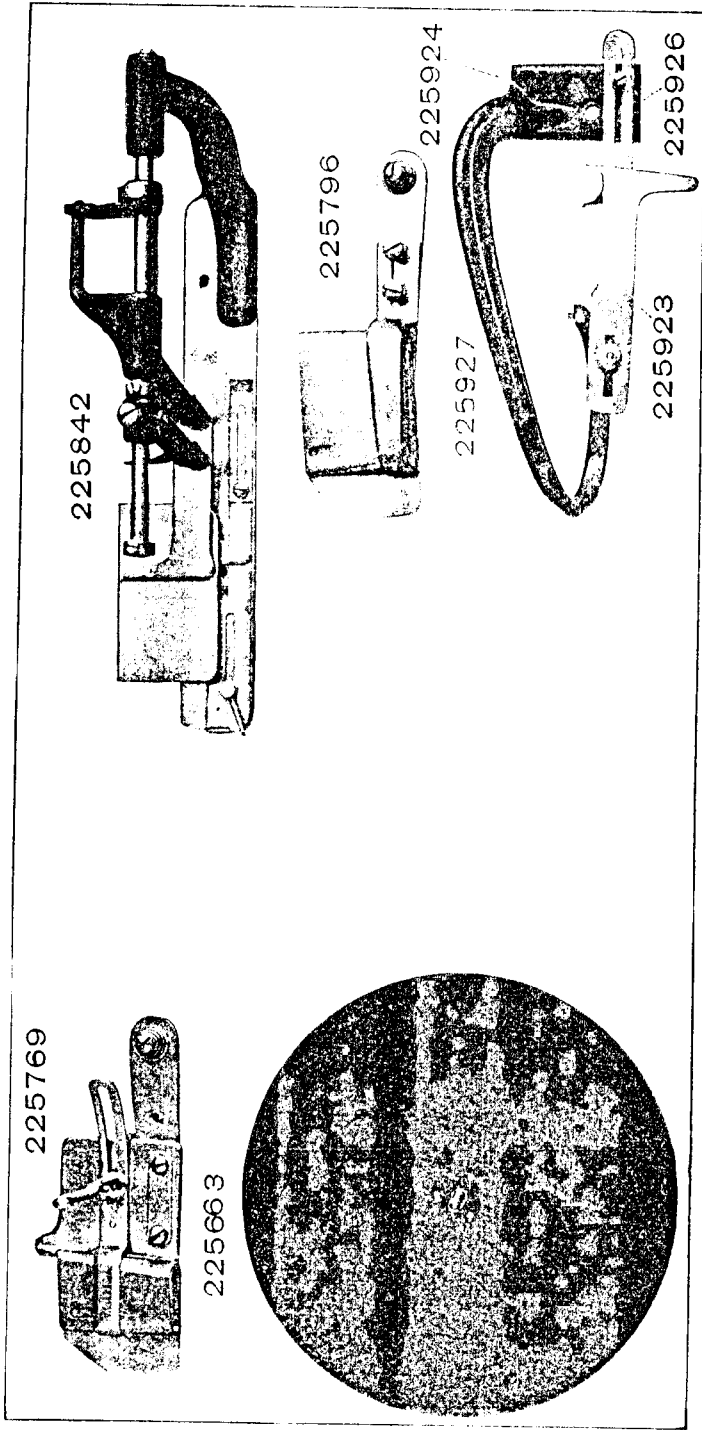


PLATE 10322—FULL SIZE

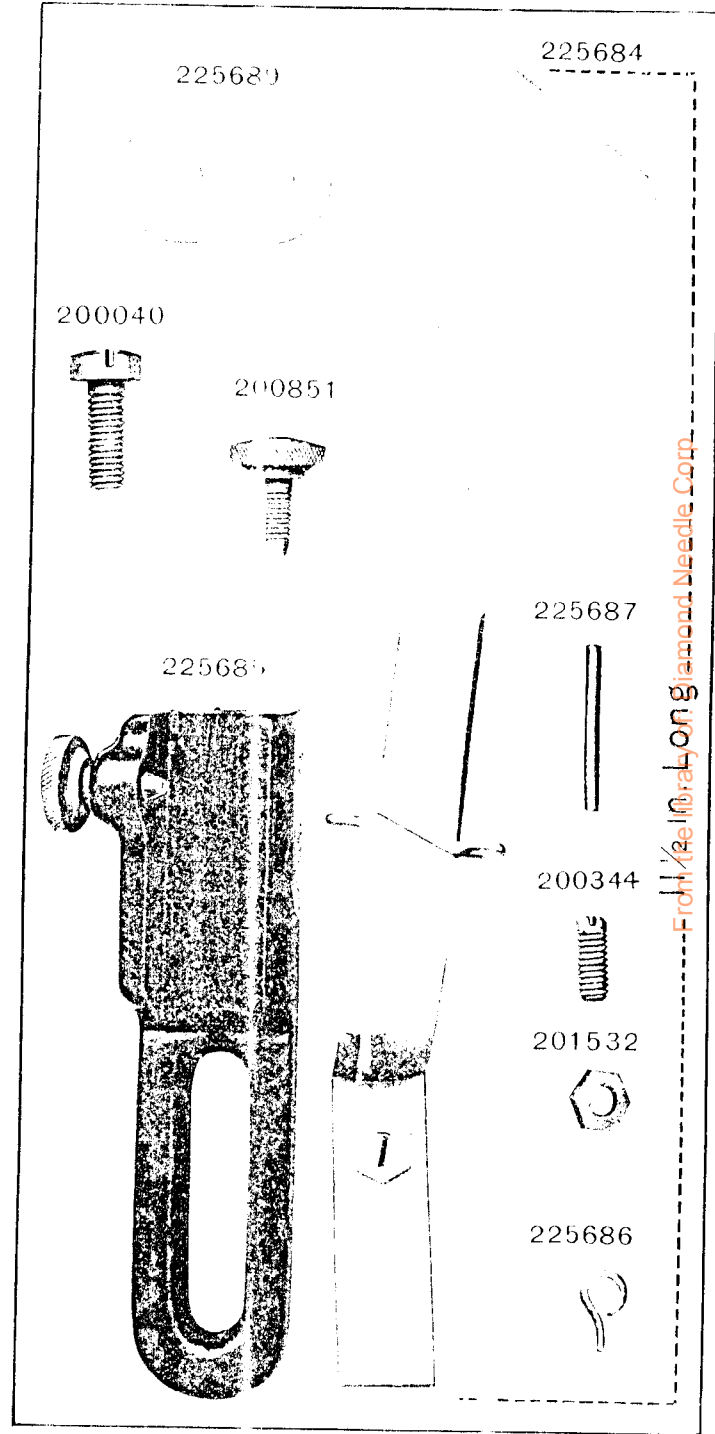


PLATE 10325—FULL SIZE

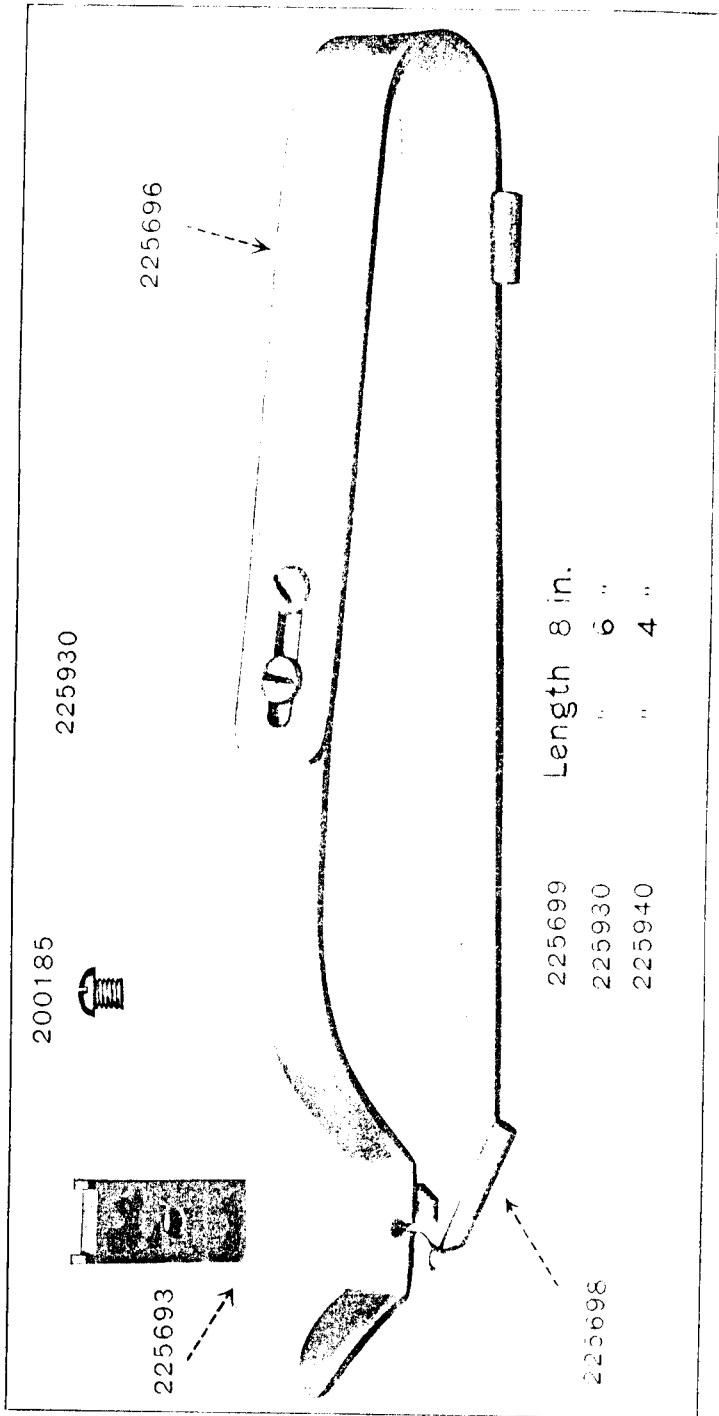
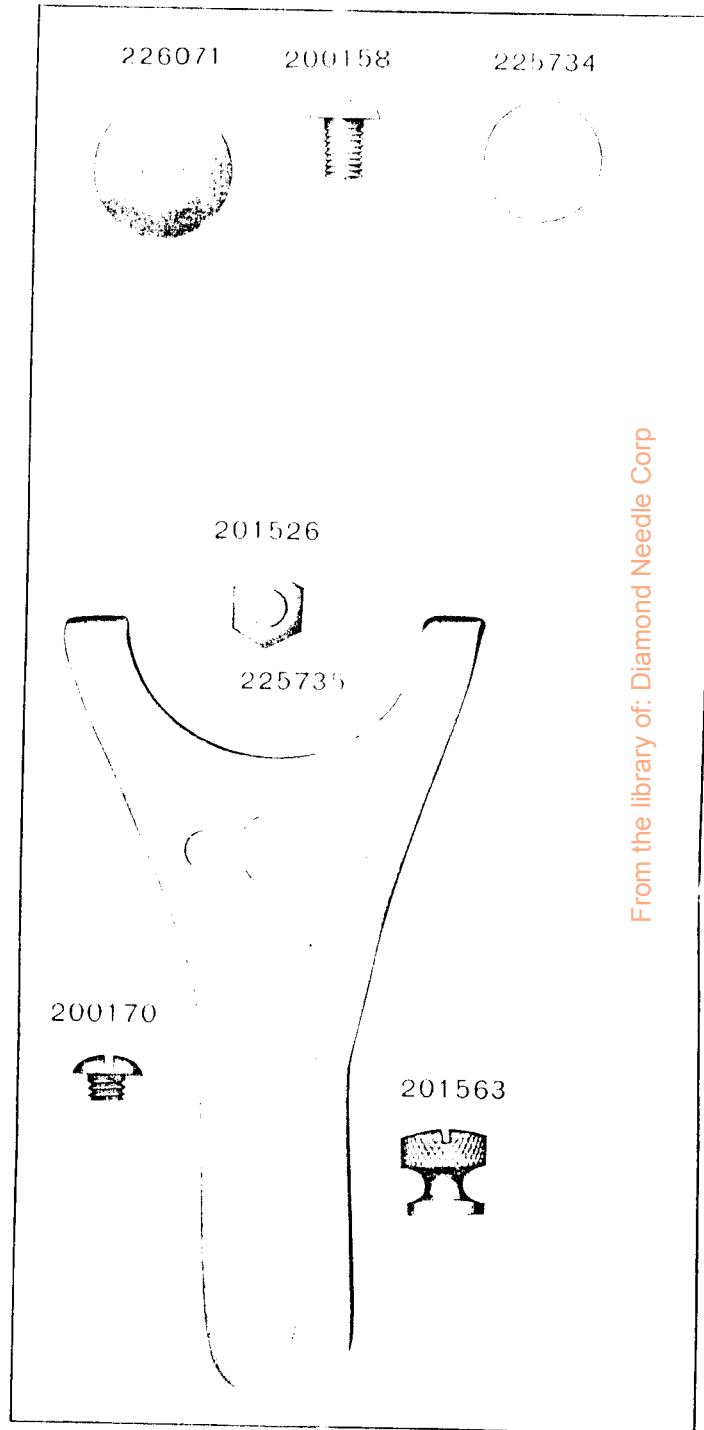


PLATE 10335—FULL SIZE



From the library of: Diamond Needle Corp

PLATE 10344—FULL SIZE

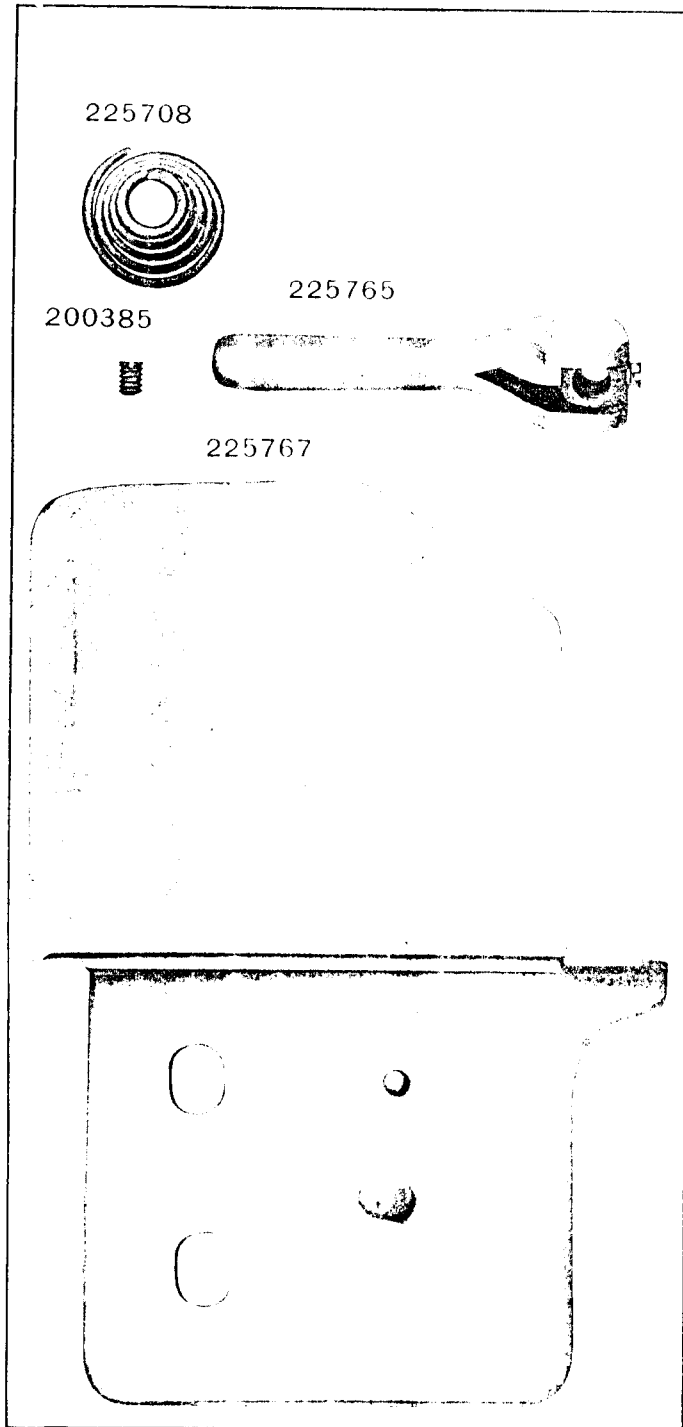
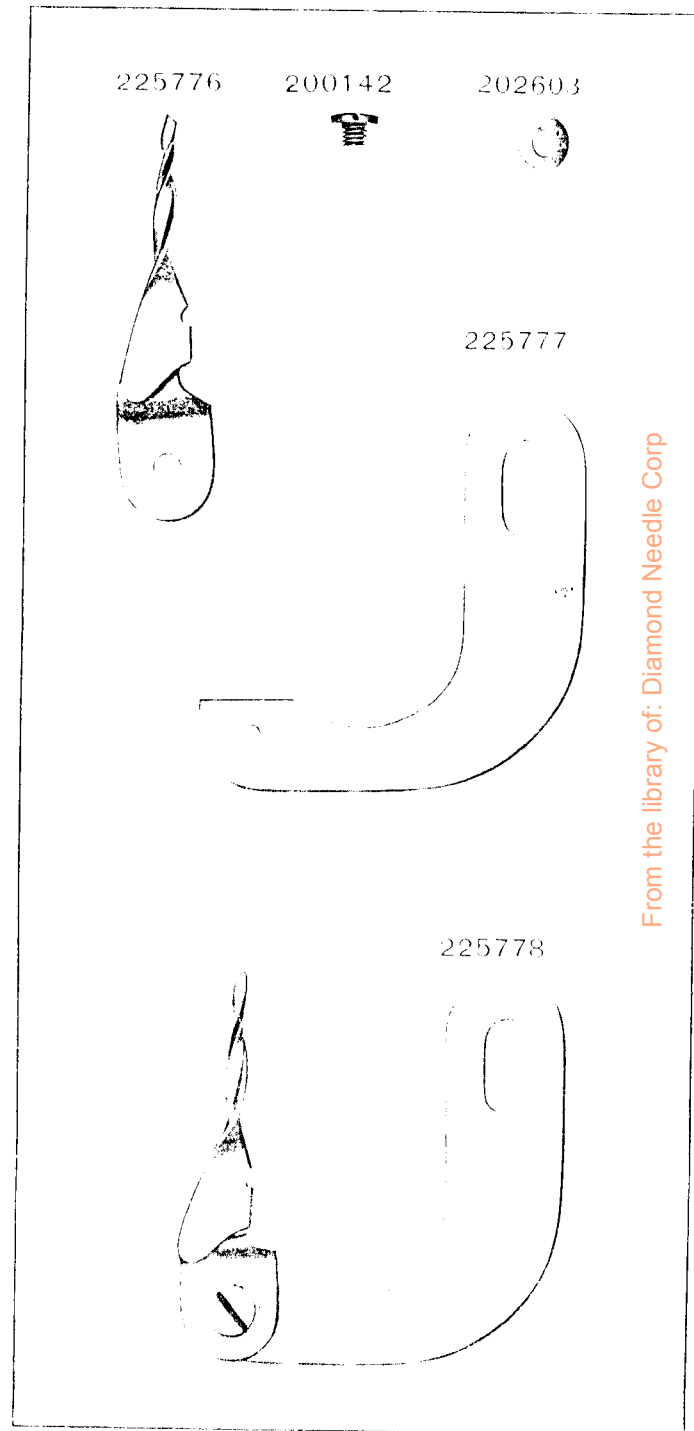


PLATE 10346—FULL SIZE



From the library of: Diamond Needle Corp

PLATE 10347—FULL SIZE

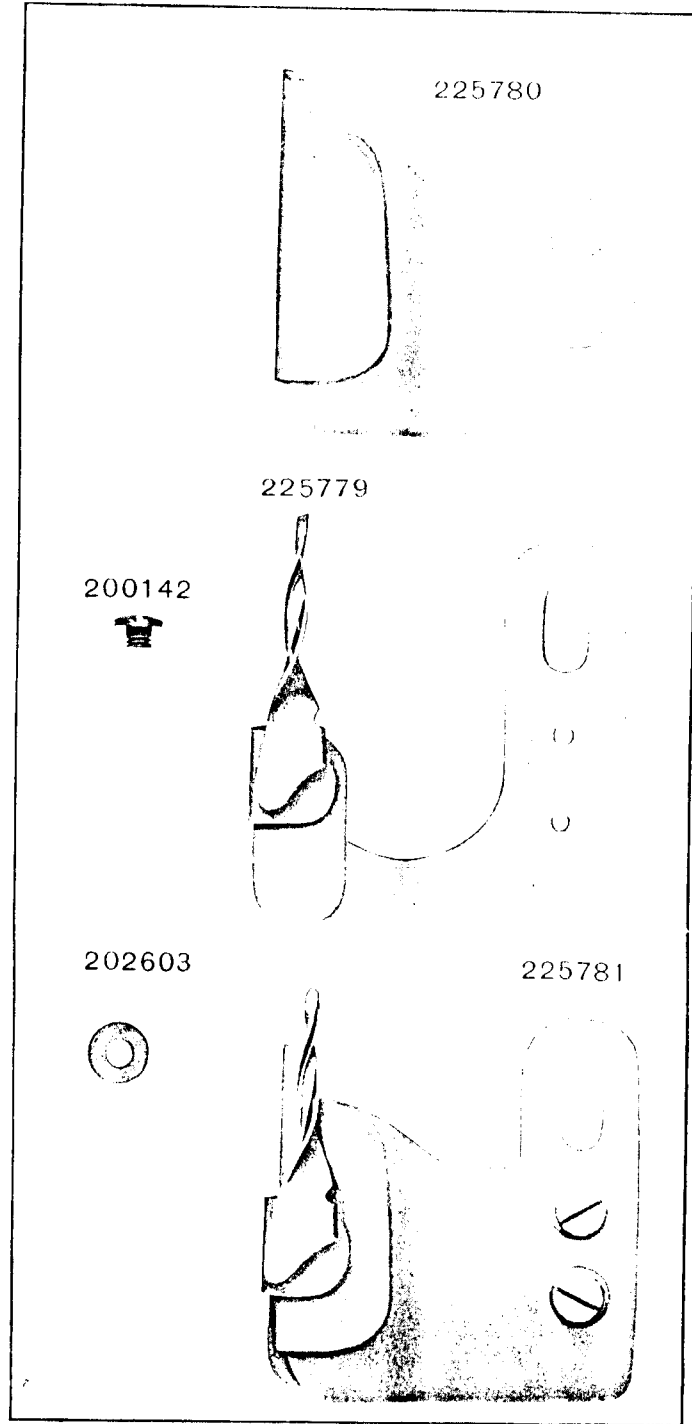
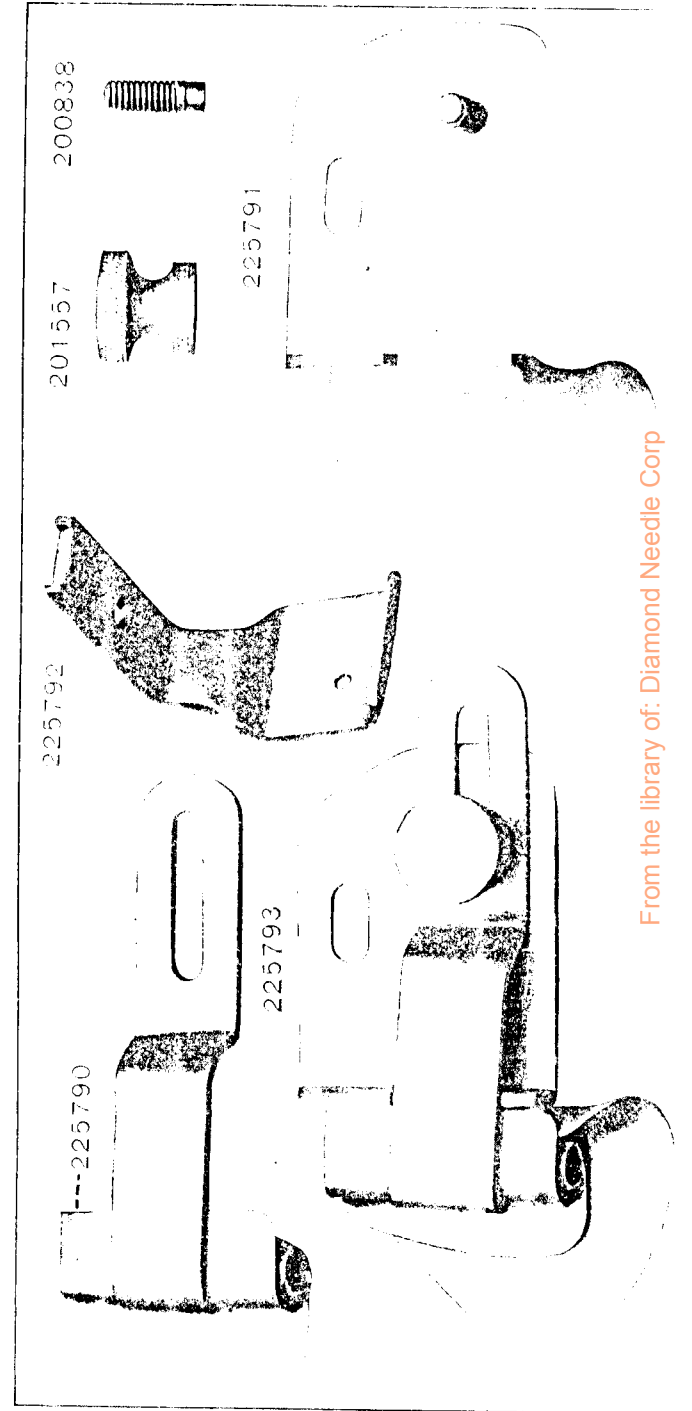


PLATE 10350—FULL SIZE



From the library of: Diamond Needle Corp

PLATE 10353—FULL SIZE

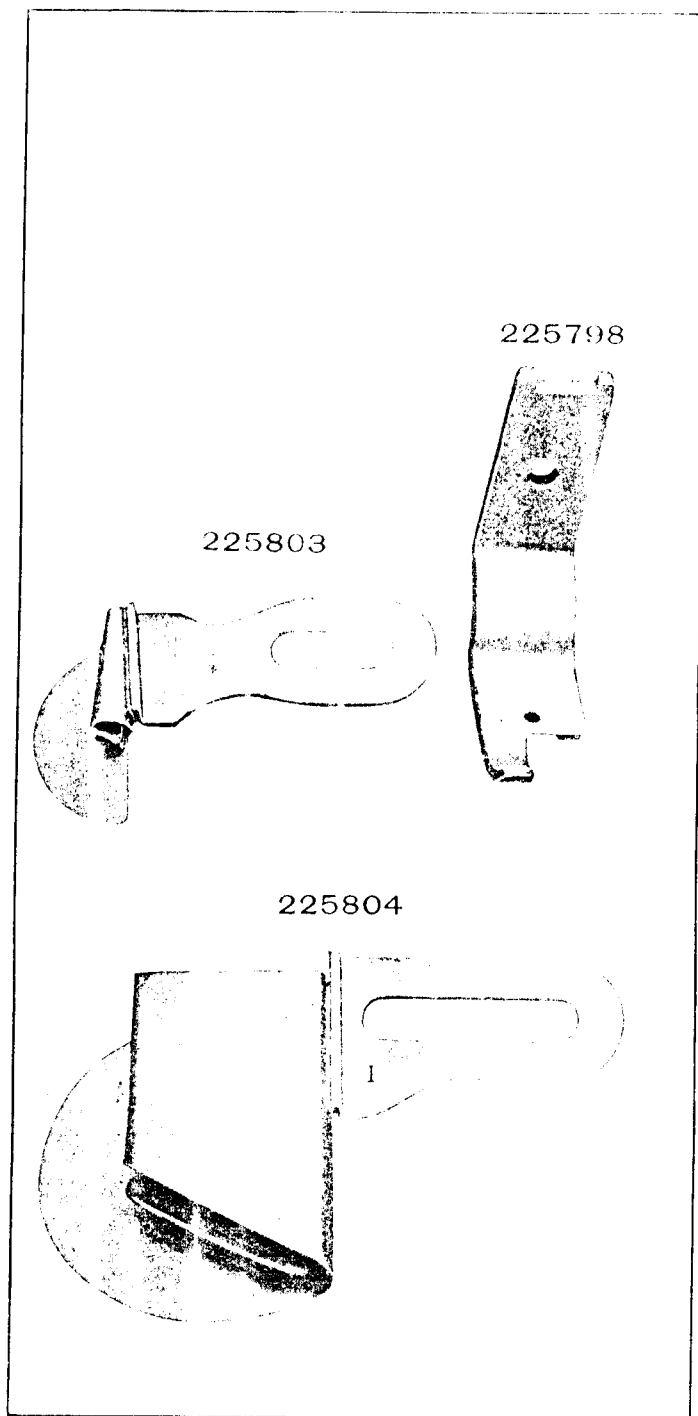


PLATE 10354—FULL SIZE

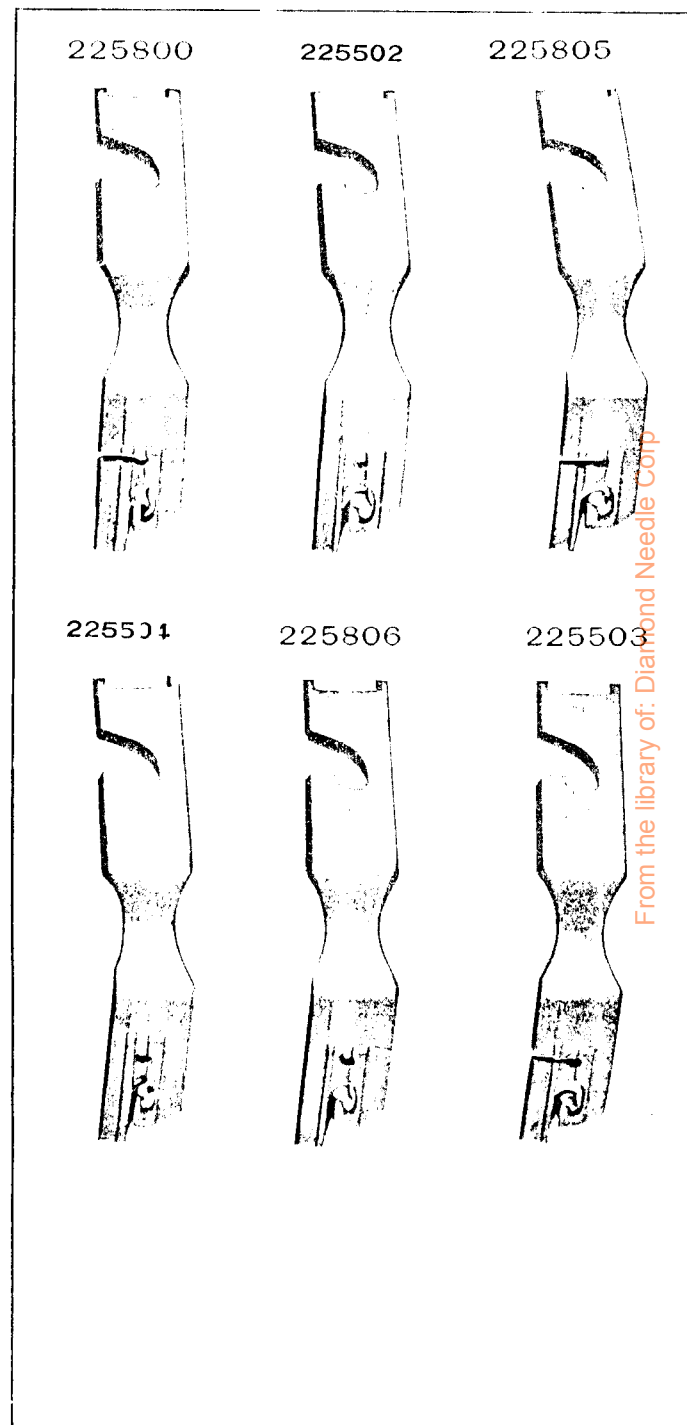


PLATE 10355—FULL SIZE

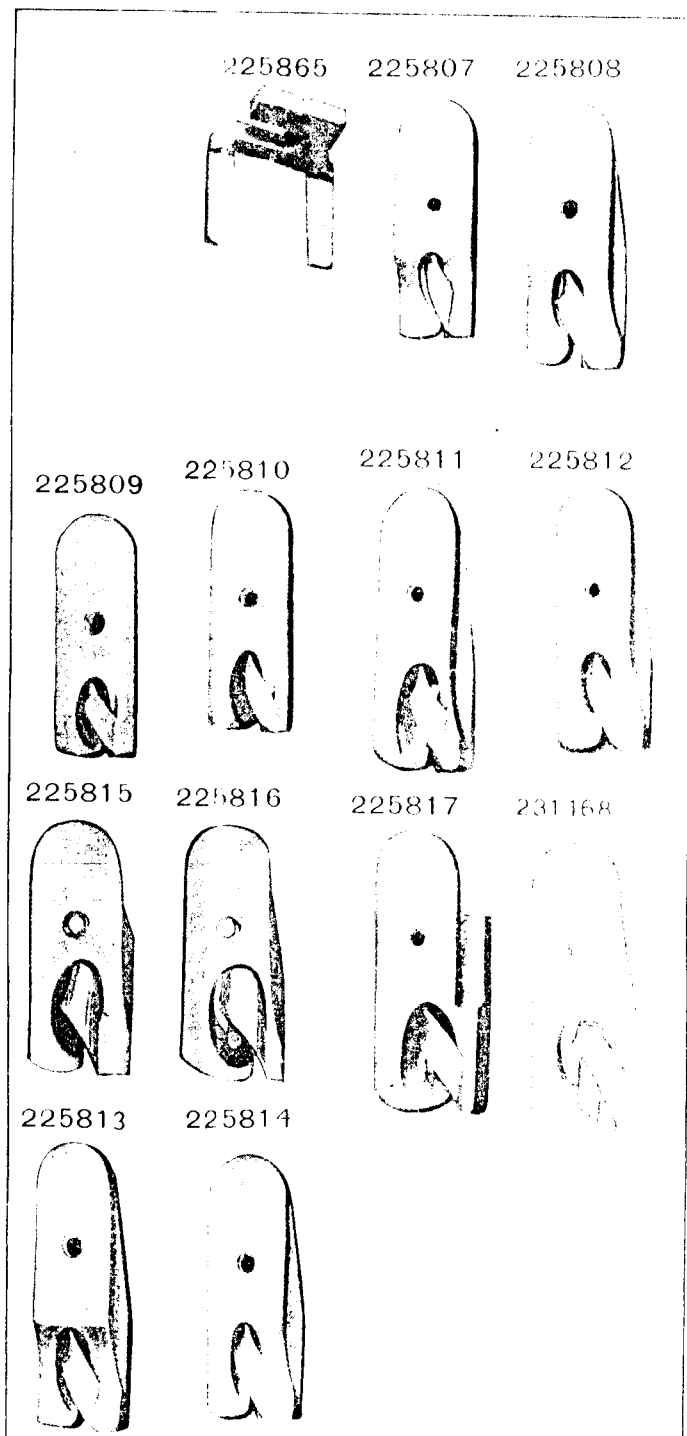
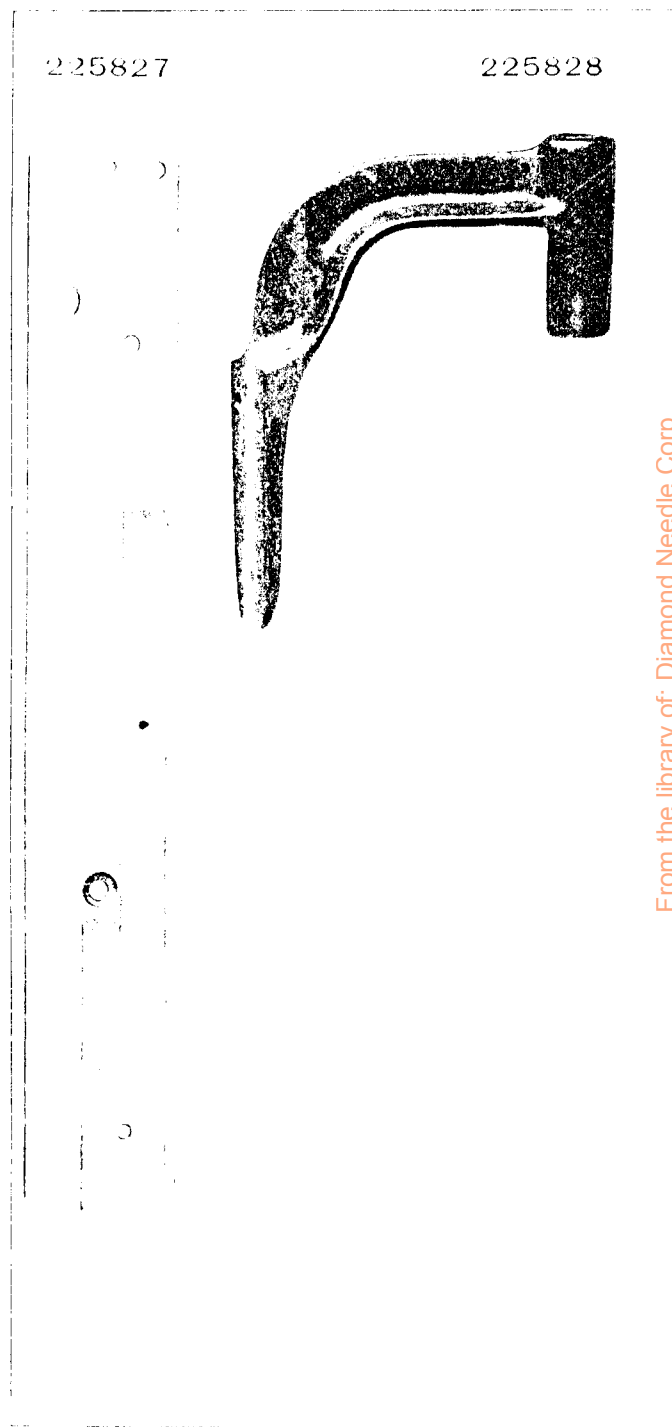


PLATE 10357—ONE-HALF SIZE



From the library of: Diamond Needle Corp

PLATE 10358—ONE-HALF SIZE

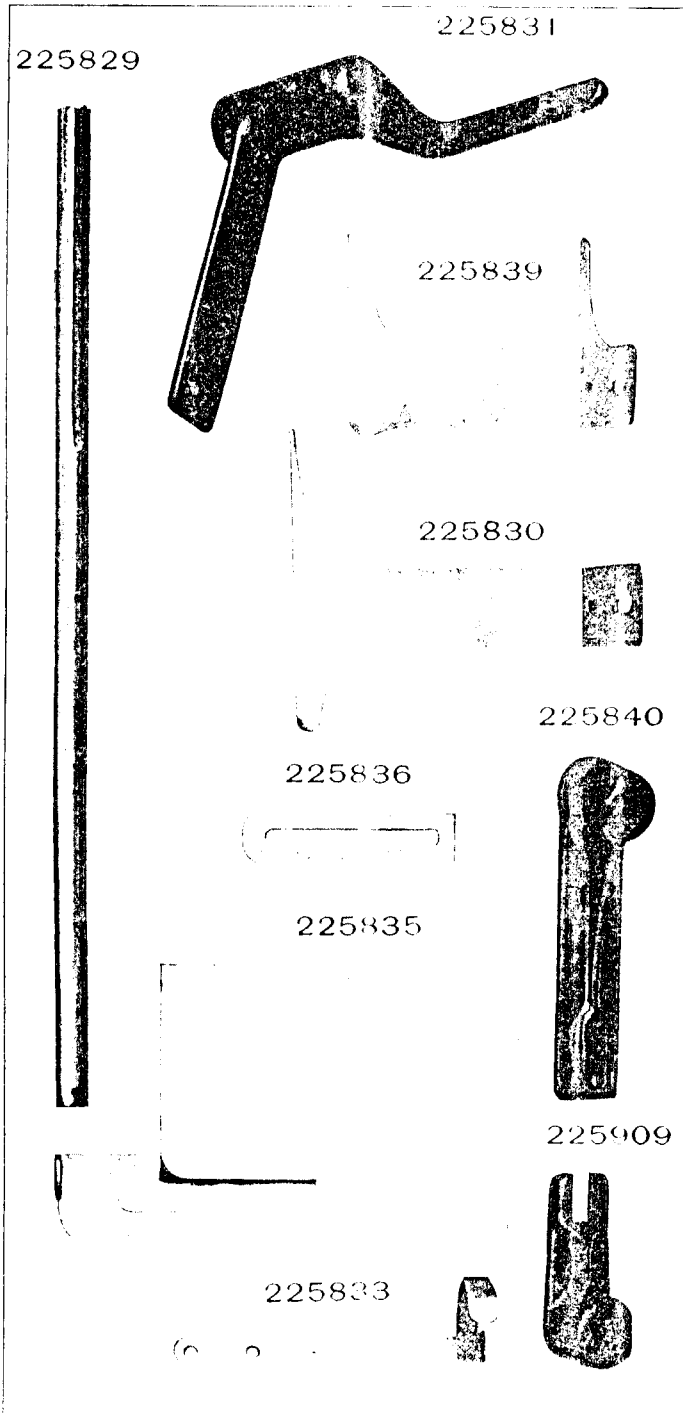
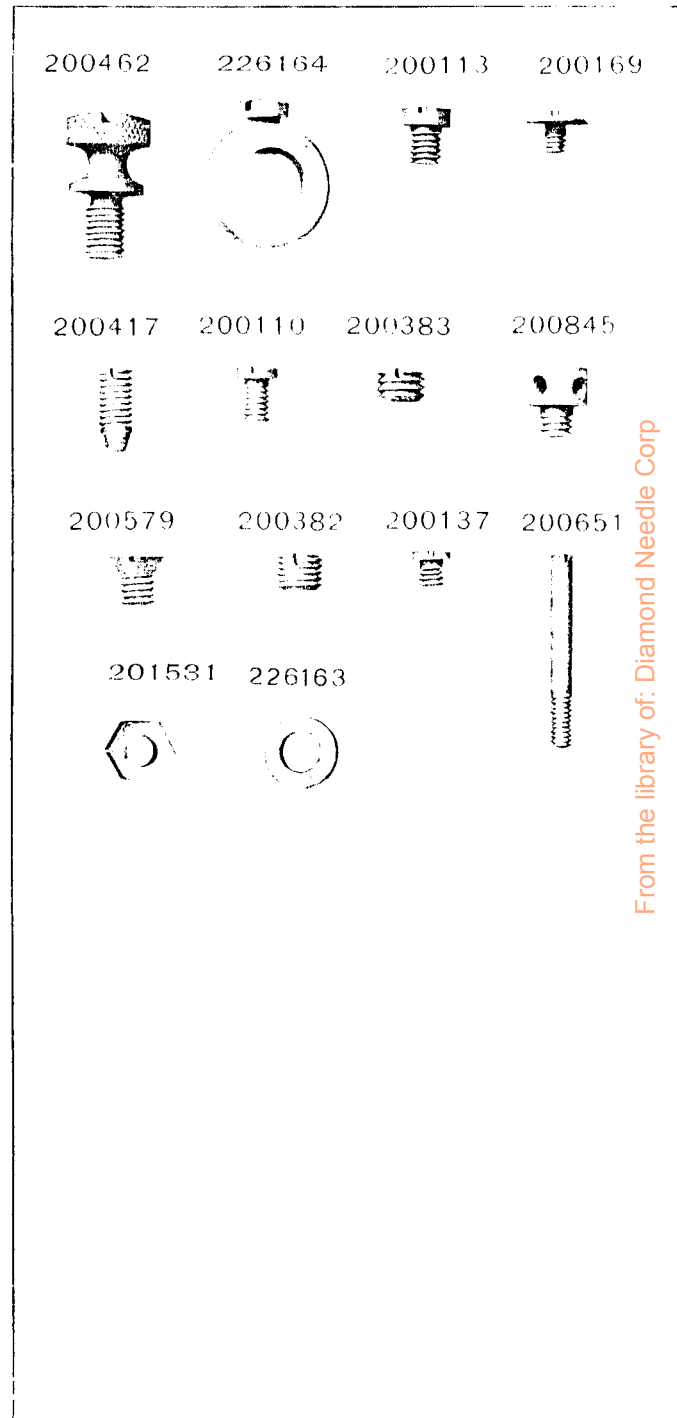


PLATE 10359—FULL SIZE



From the library of: Diamond Needle Corp

PLATE 10360—FULL SIZE

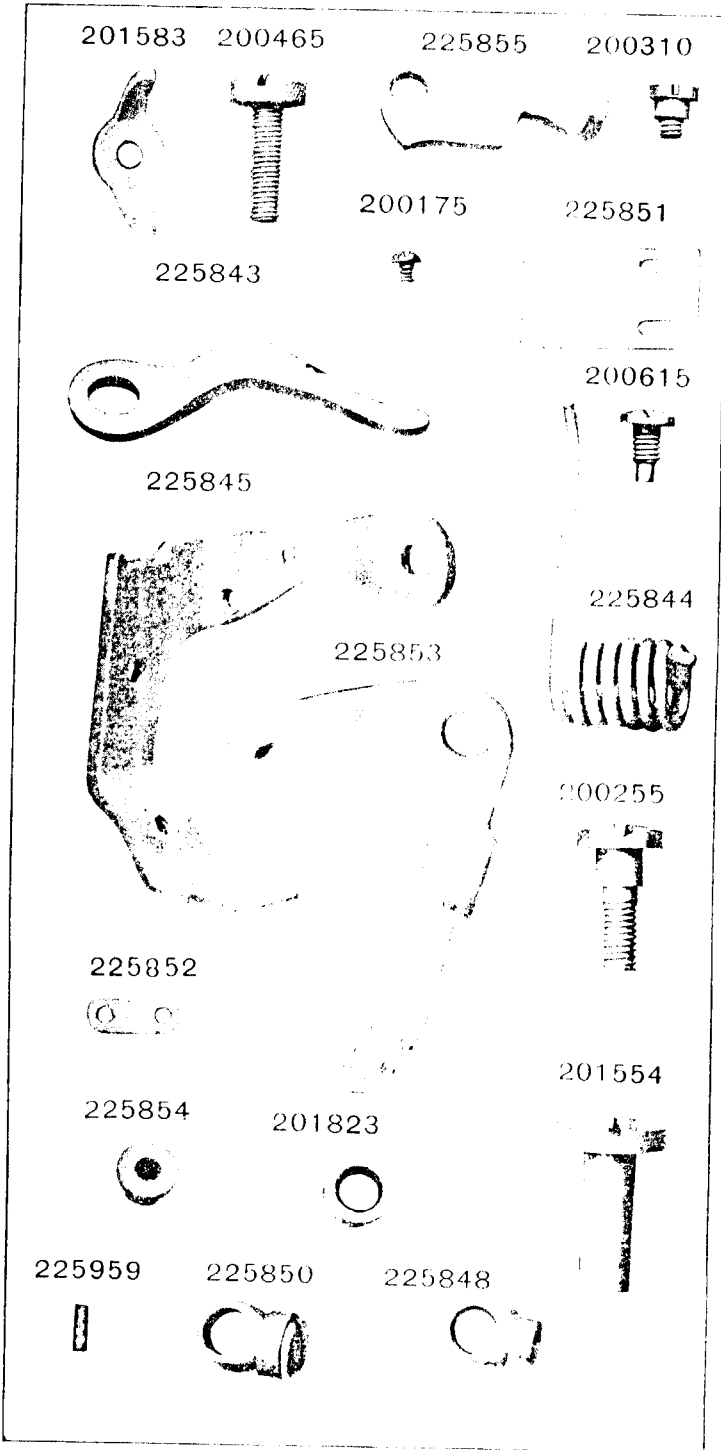
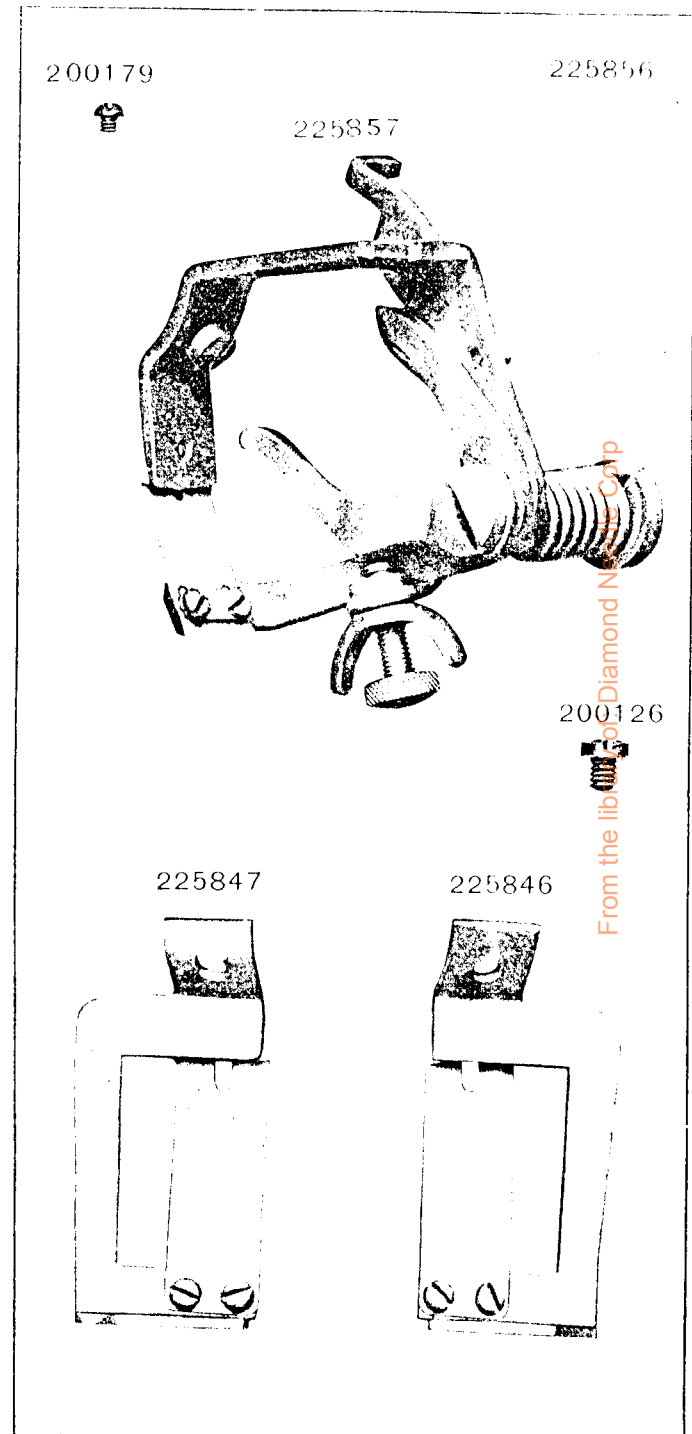


PLATE 10361—FULL SIZE



From the lib. of the National Archives



PLATE 10381—FULL SIZE

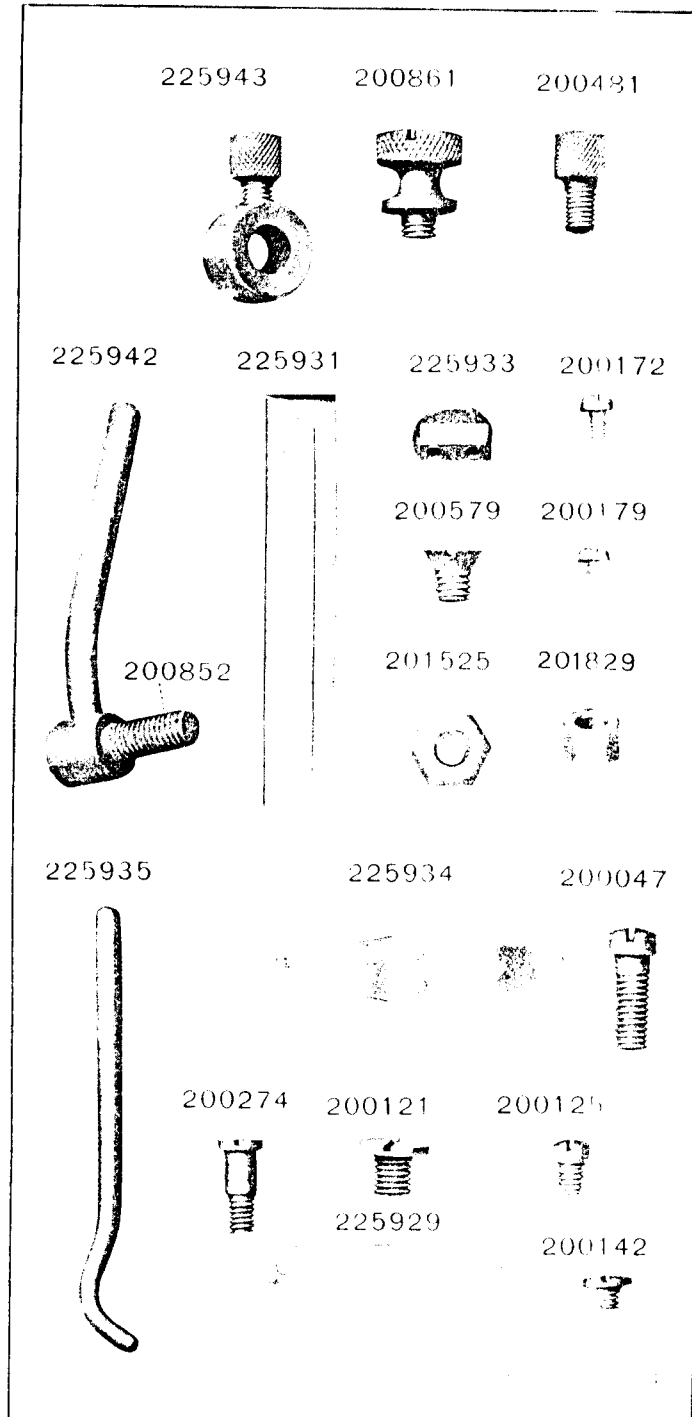
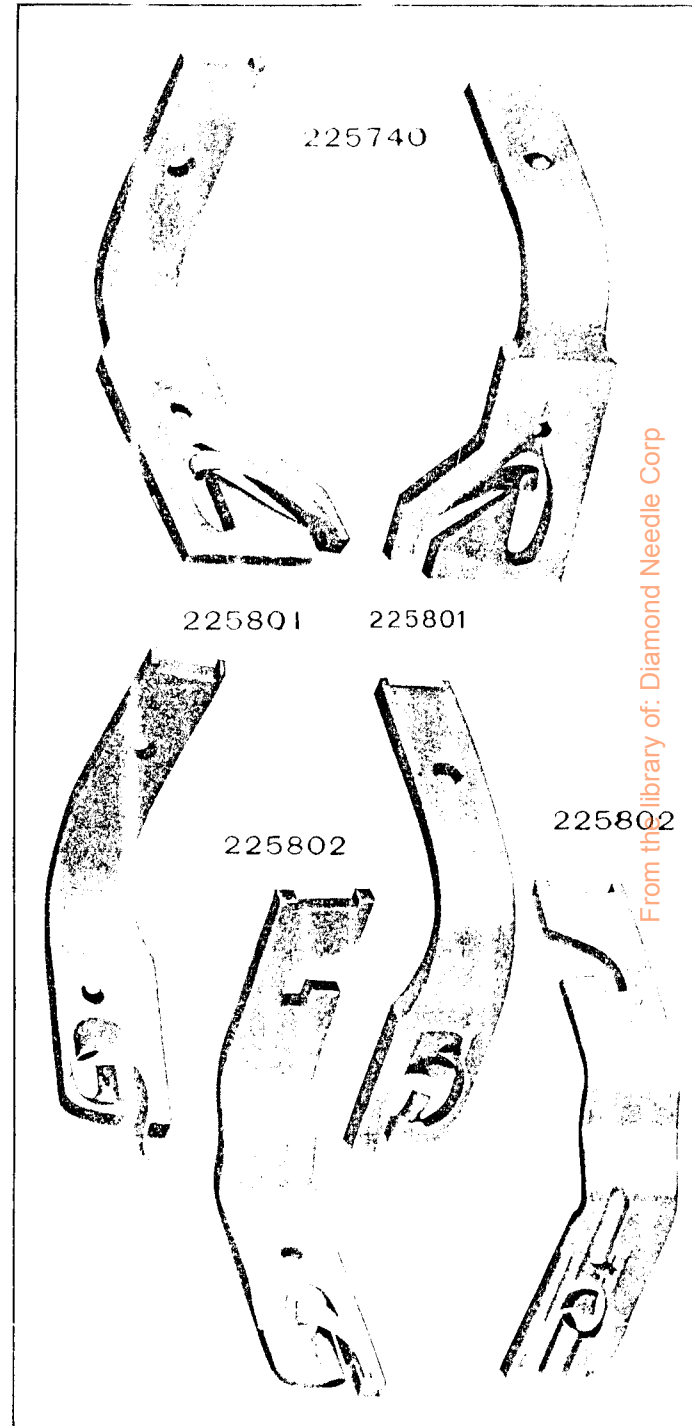


PLATE 10393—FULL SIZE



From the library of: Diamond Needle Corp

PLATE 10511 -FULL SIZE

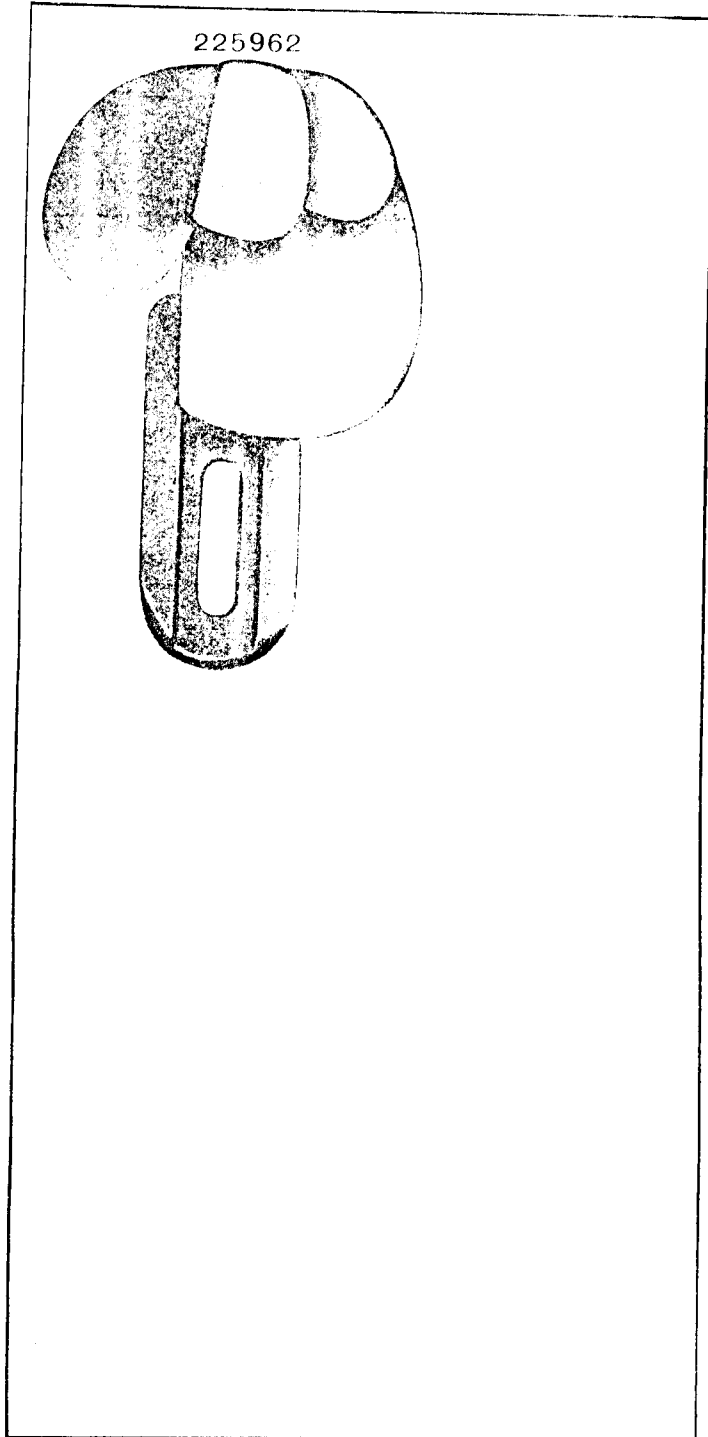
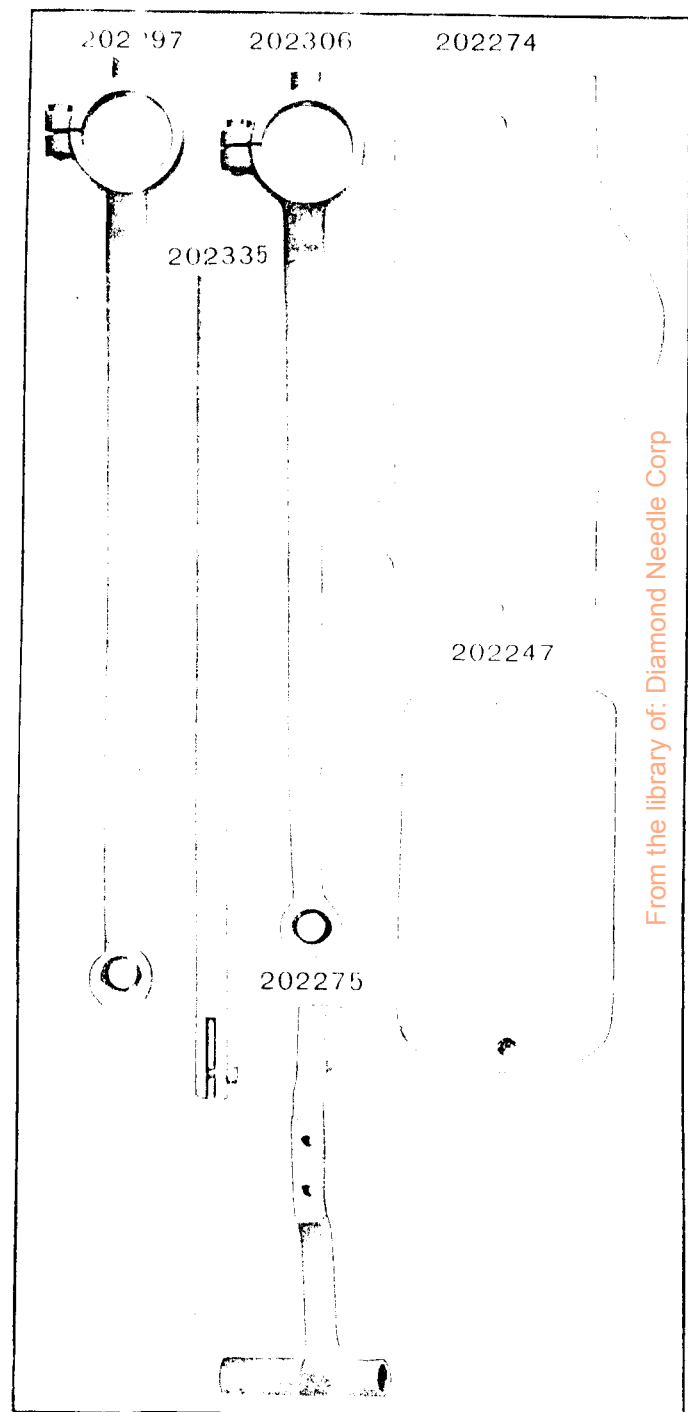


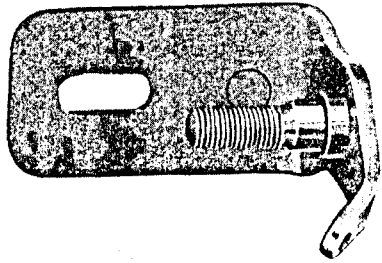
PLATE 10667 -ONE - HALF SIZE



From the library of: Diamond Needle Corp

PLATE 10881—FULL SIZE

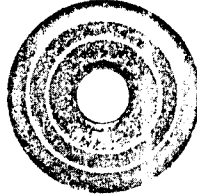
225461



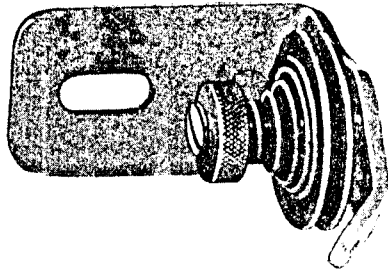
200082 202104



2102



225462



202407



201499

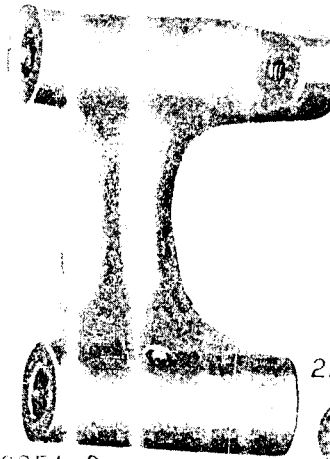


201572

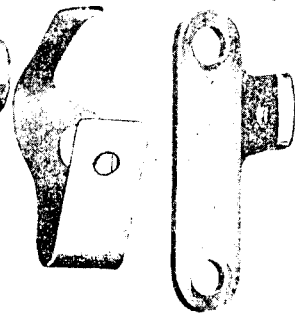


PLATE 10884—FULL SIZE

225453



225444 202478



225458



228026



225450



225451



200299



225458



200056



225459



200105



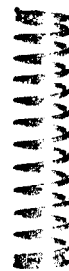
225456



225381



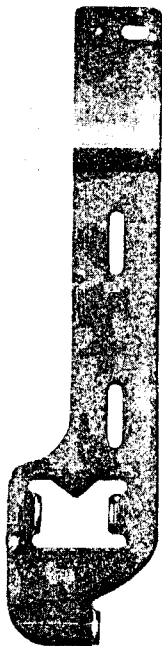
225455



From the library of: Diamond Needle Corp

PLATE 10885—ONE-FOURTH SIZE

225433



202473

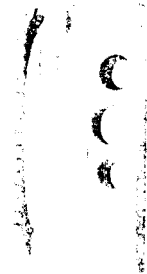


225382



PLATE 10912 —FULL SIZE

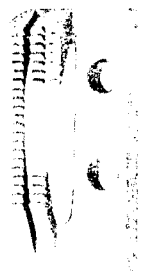
202290



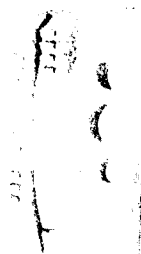
202293



202294



202295



202296

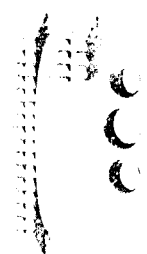


From the library of: Diamond Needle Corp

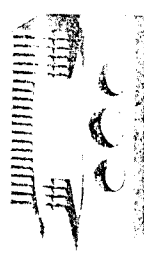
202970



203071



203072

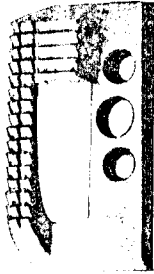


203083

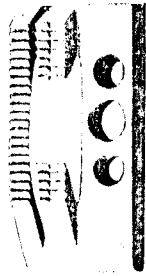


PLATE 10913 -FULL SIZE

202278



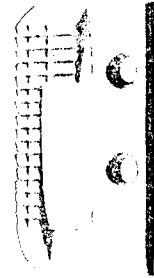
202281



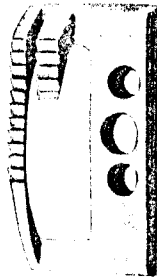
202282



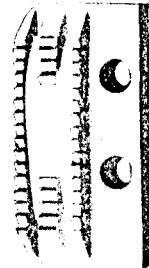
202283



202284



202287



202289

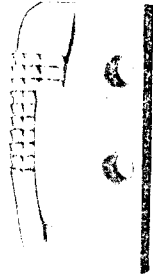
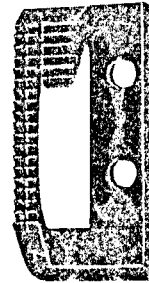


PLATE 10915 -FULL SIZE

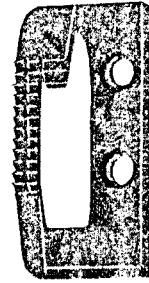
207051



207052



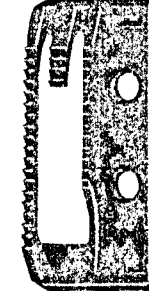
207053



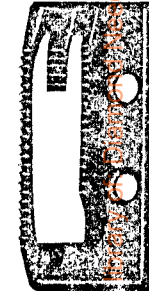
207054



207055



207056



From the [www.fishbase.org](http://www.fishbase.org) database Corp

PLATE 10917 -FULL SIZE

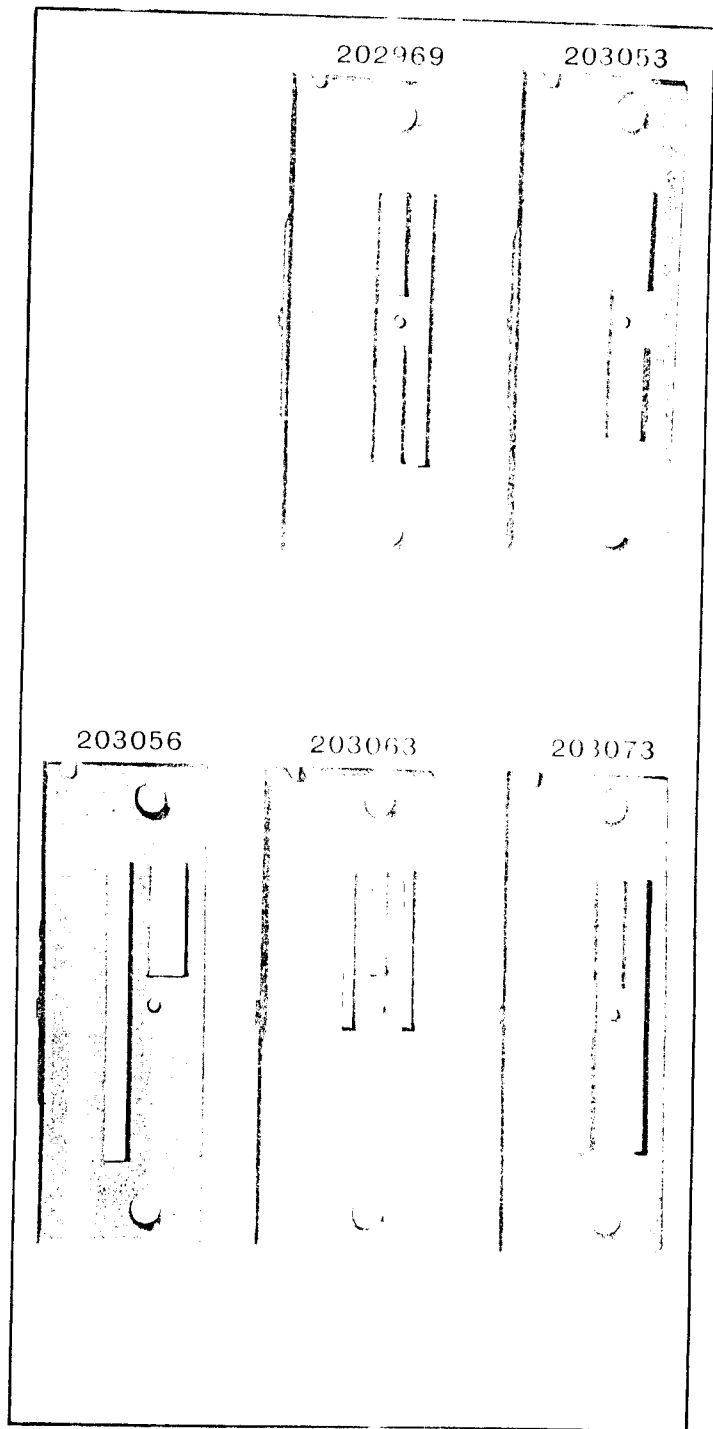
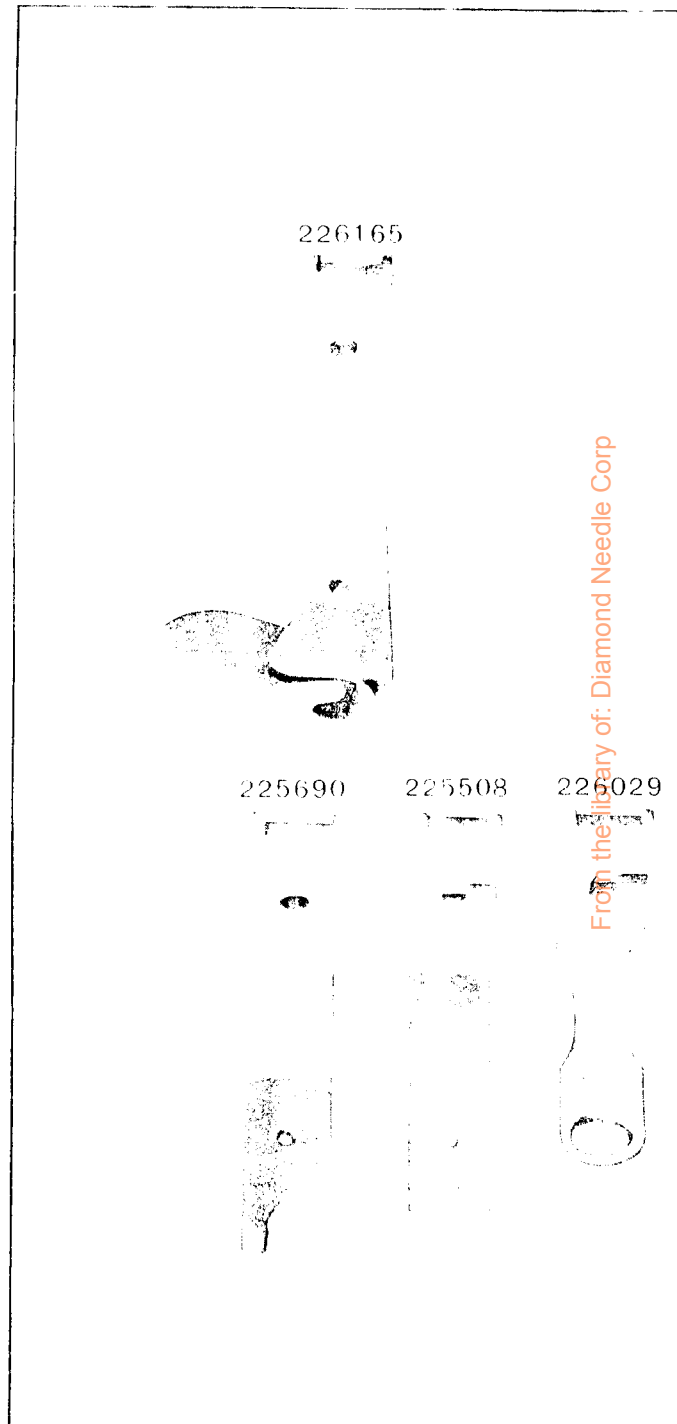


PLATE 10923 -FULL SIZE



From the library of: Diamond Needle Corp

PLATE 10925 - FULL SIZE

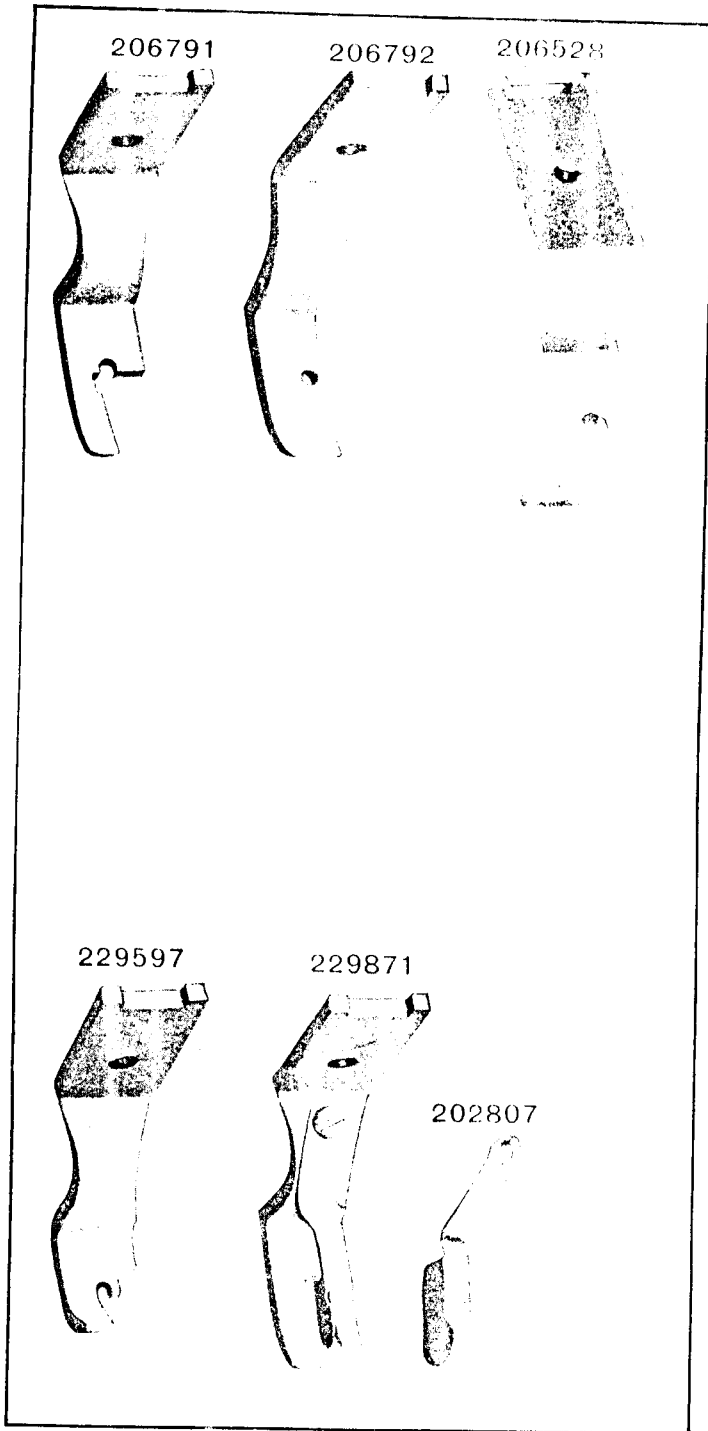
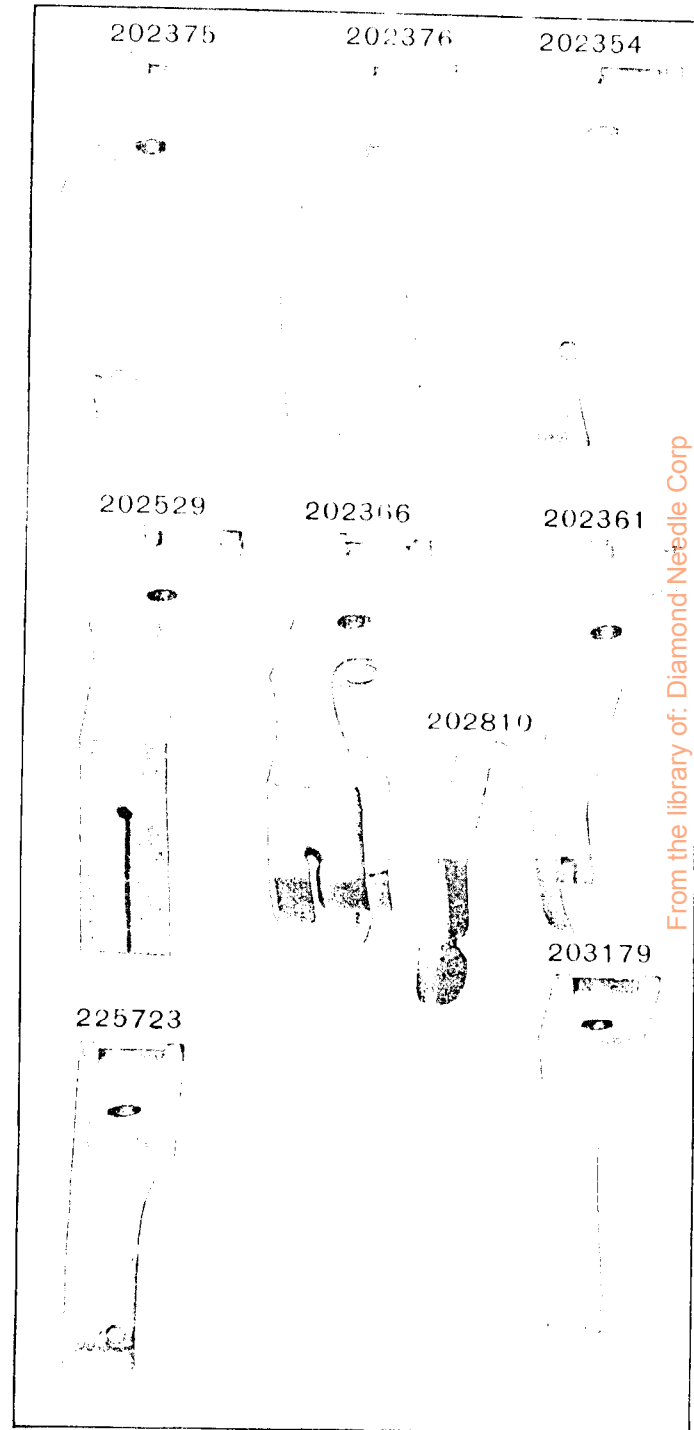


PLATE 10926 - FULL SIZE



From the library of: Diamond Needle Corp

PLATE 10927 -FULL SIZE

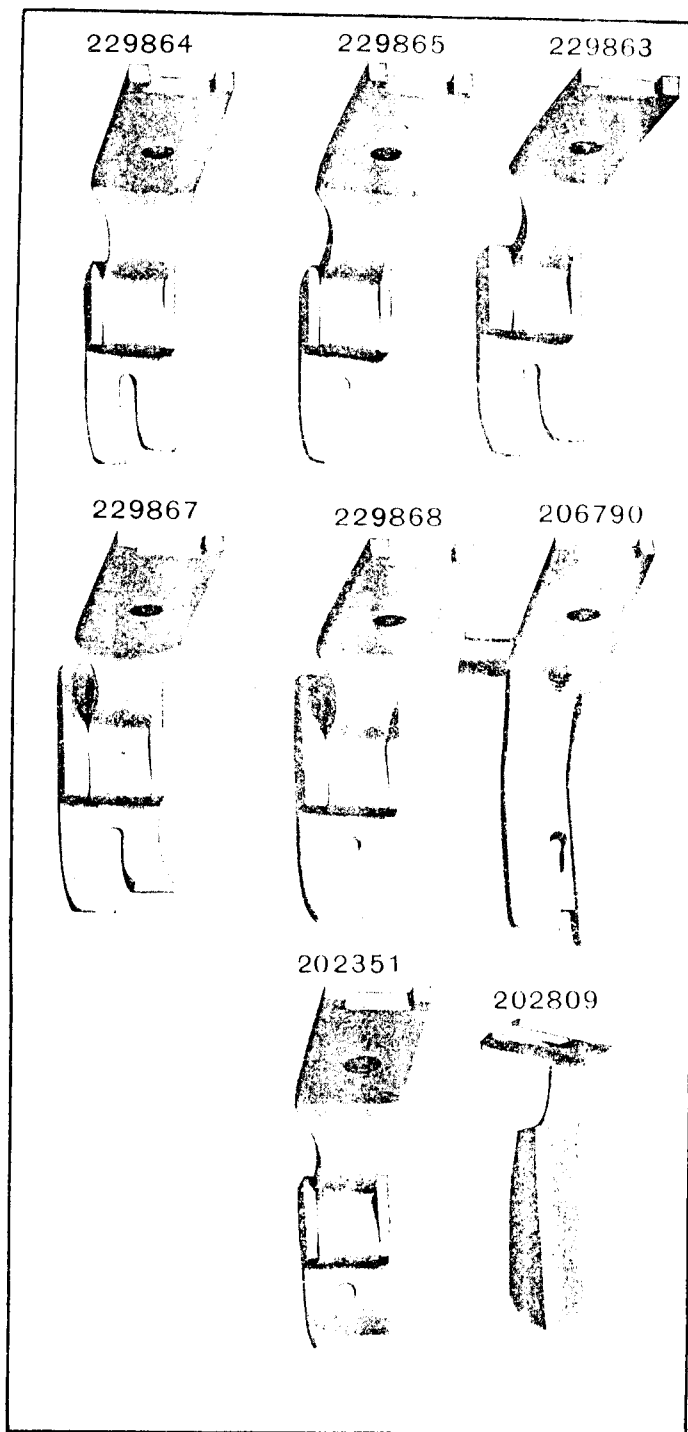
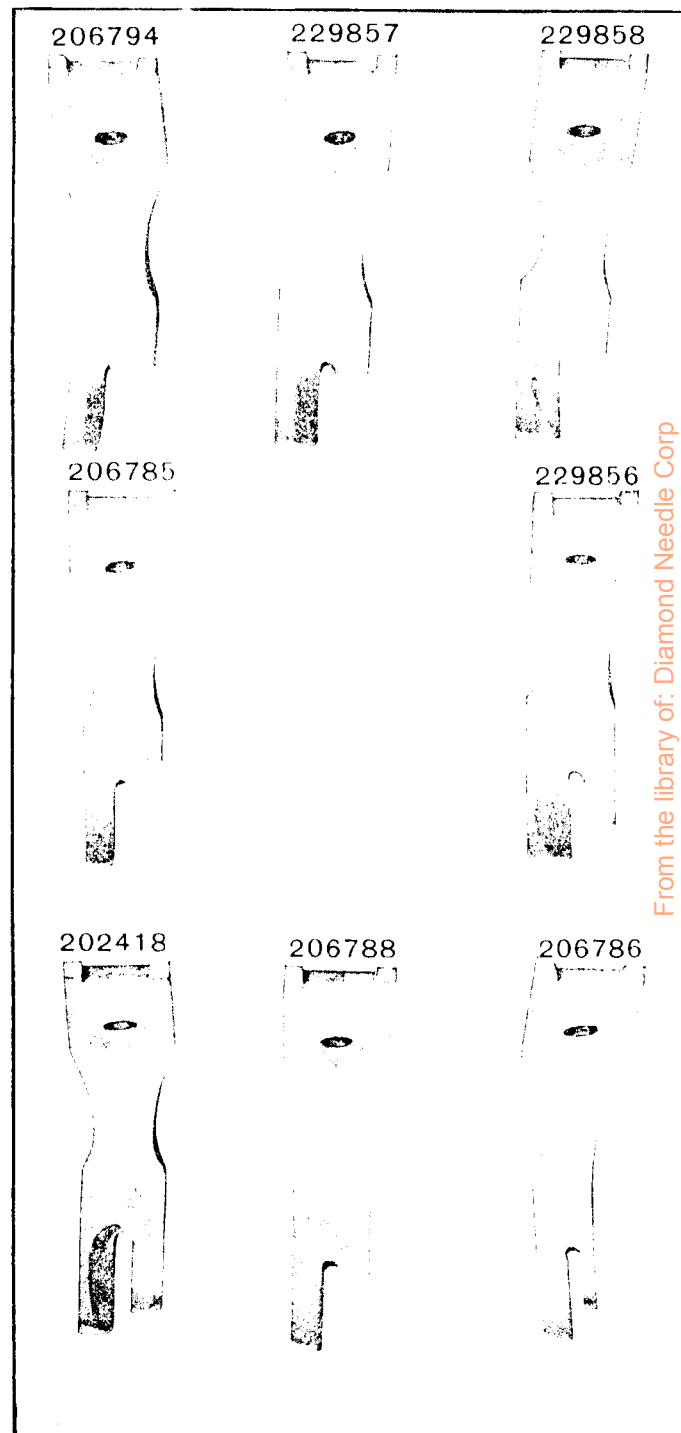


PLATE 10929 -FULL SIZE



From the library of: Diamond Needle Corp



PLATE 11598—FULL SIZE

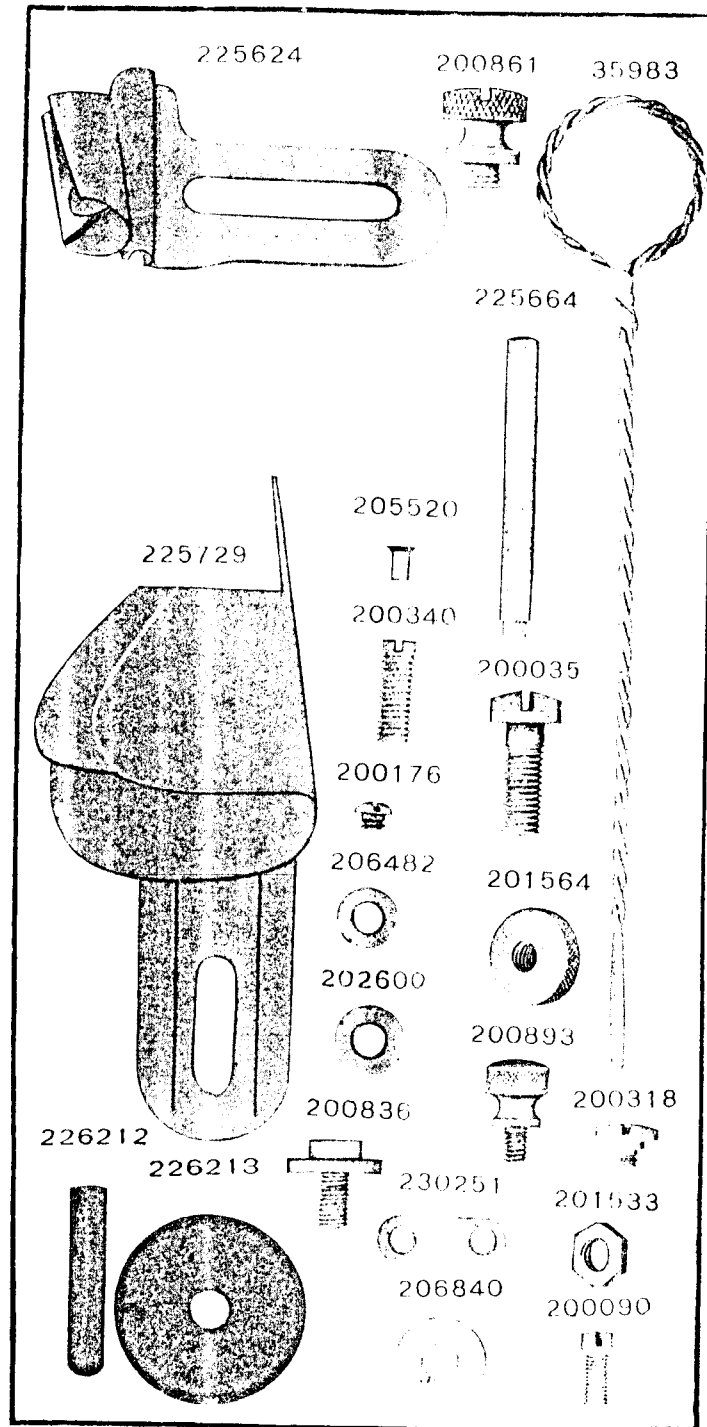


PLATE 11599—ONE-HALF SIZE

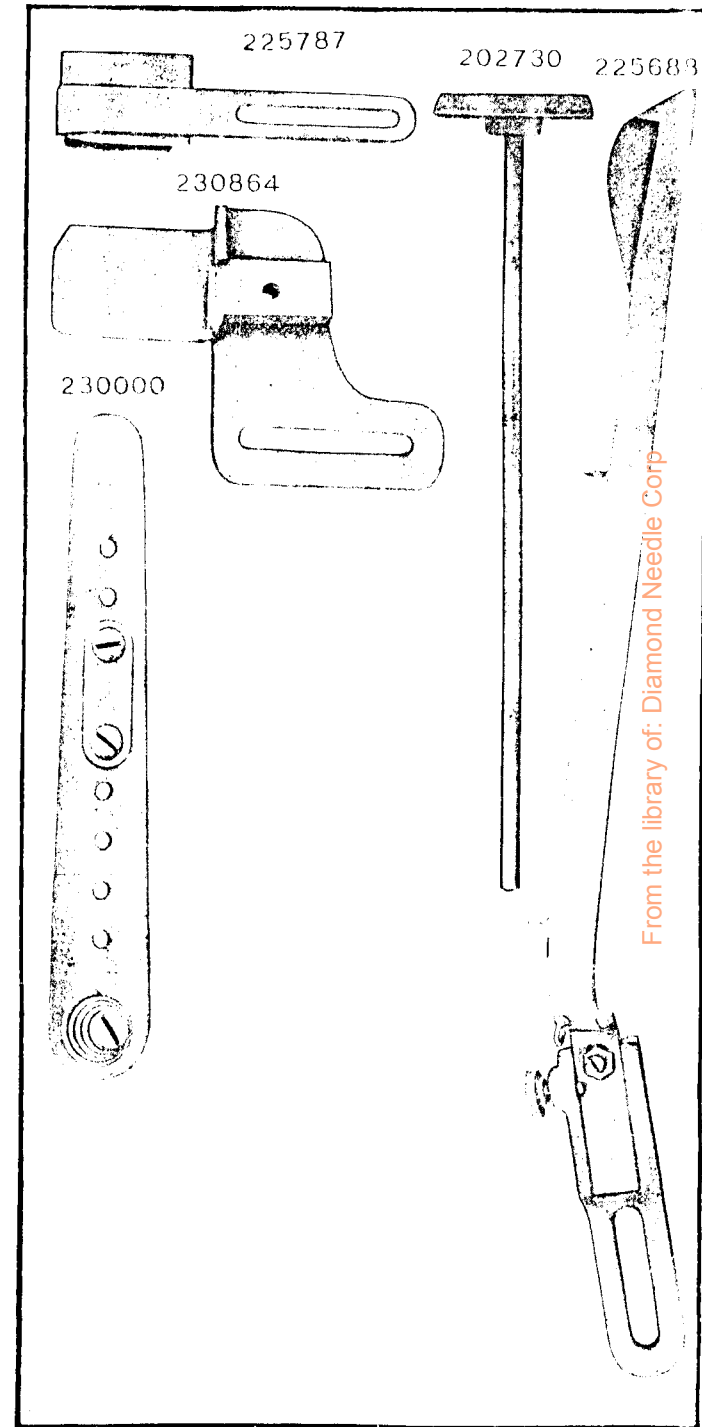


PLATE 11600-FULL SIZE

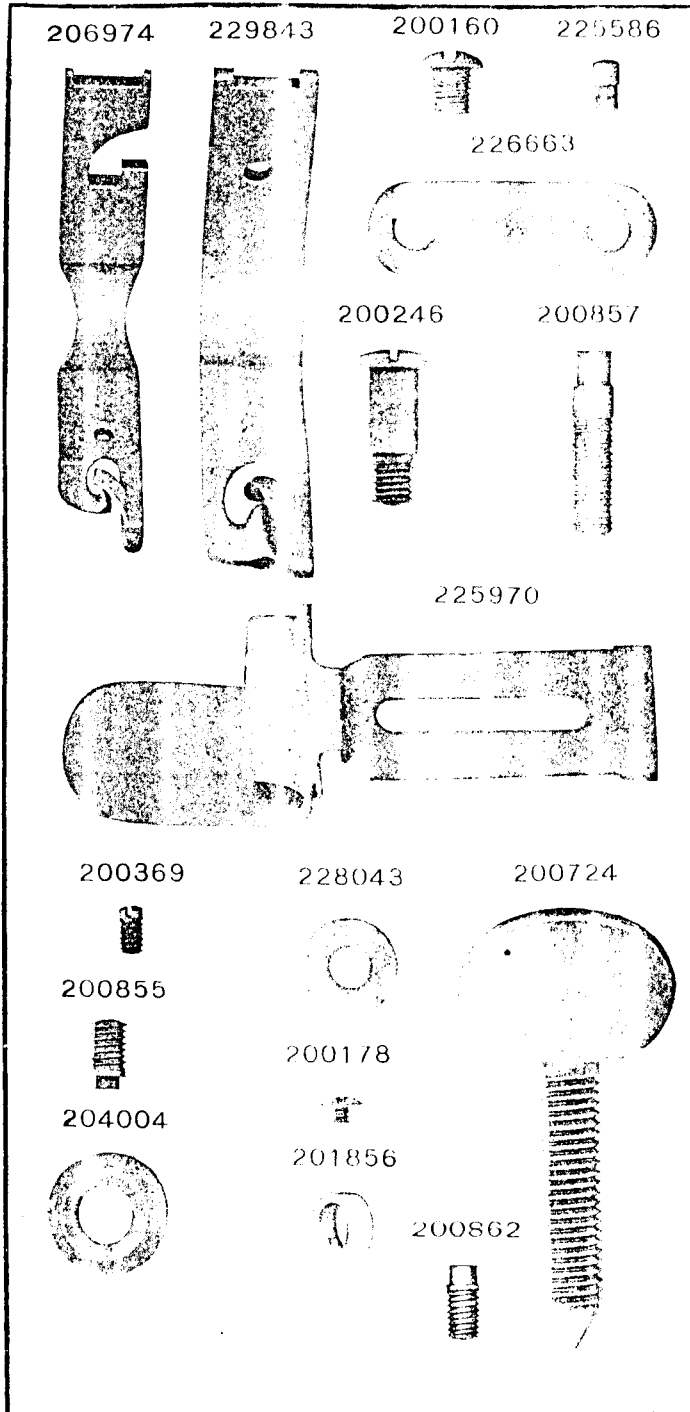
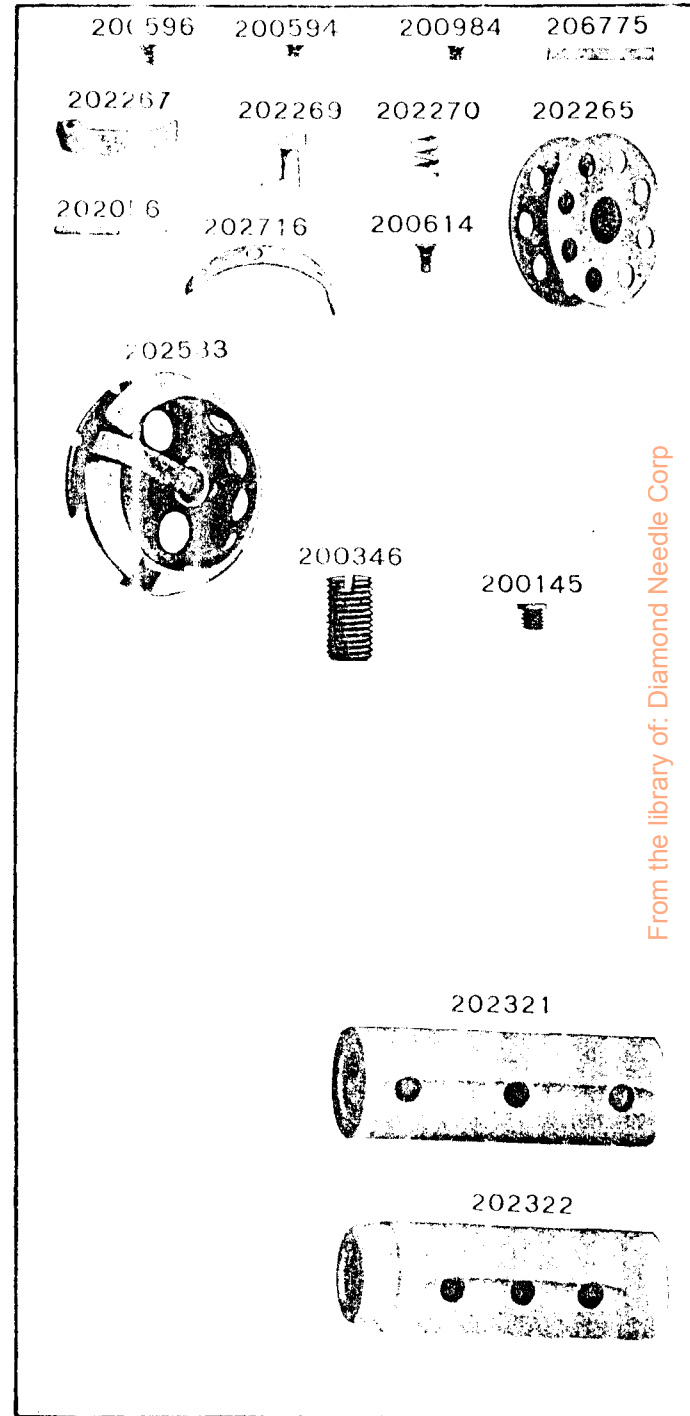


PLATE 11671-FULL SIZE



From the library of: Diamond Needle Corp

PLATE 12153-ONE-HALF SIZE

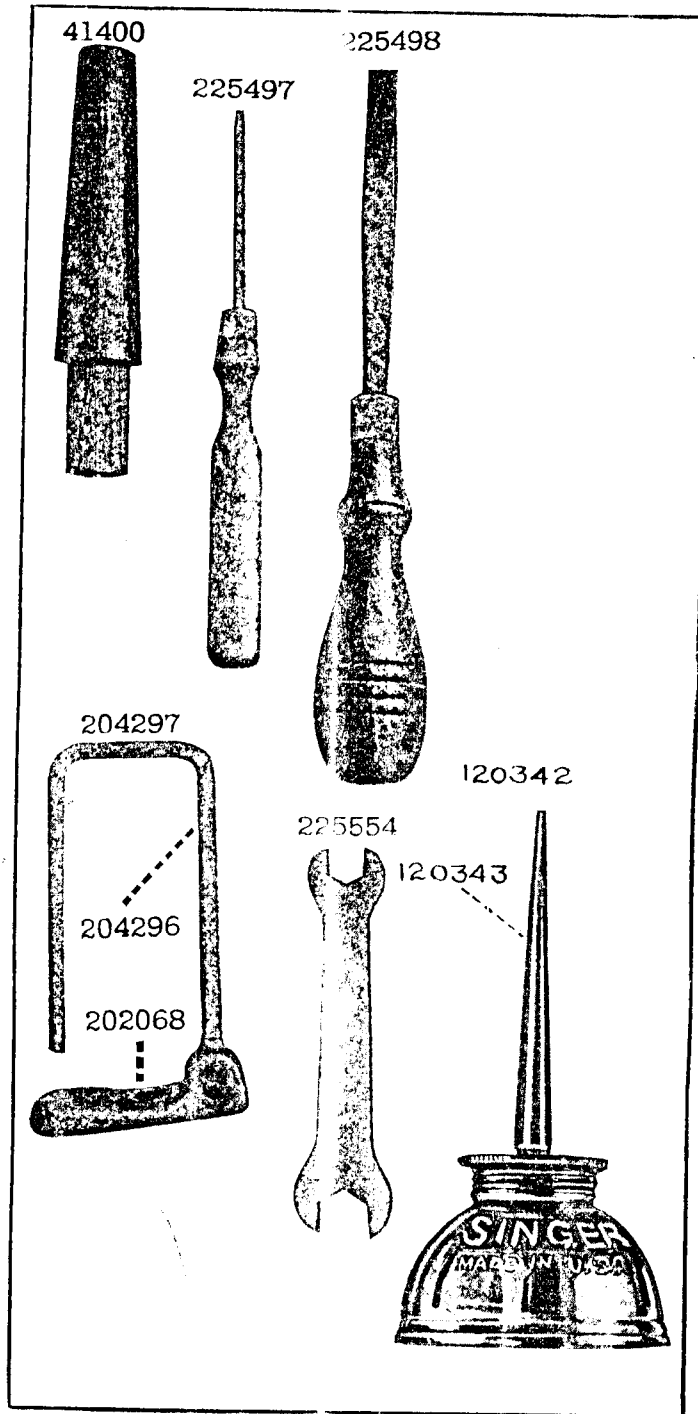


PLATE 13351-ONE-HALF SIZE

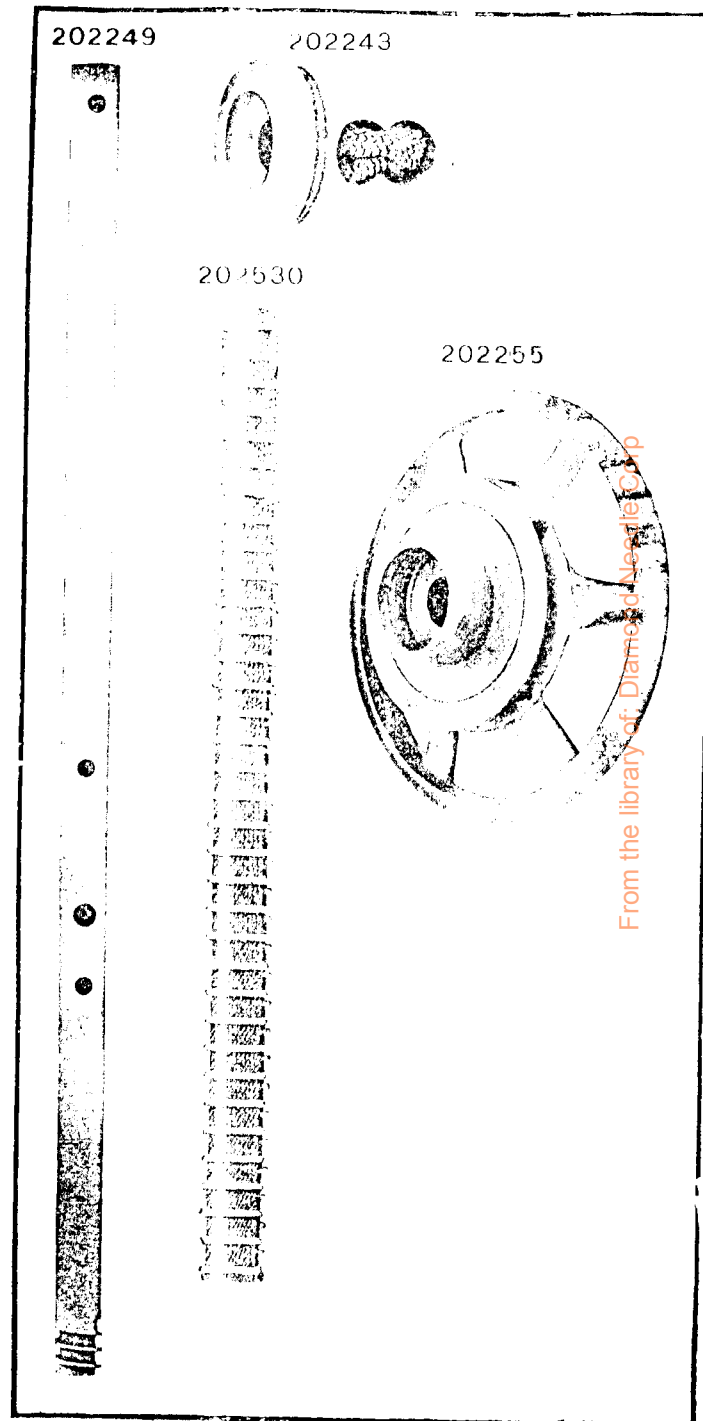
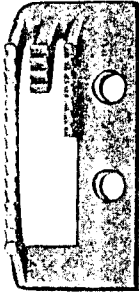
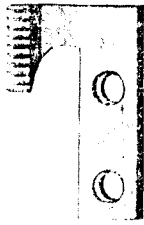


PLATE 13354 -FULL SIZE

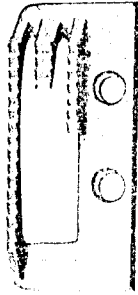
203136



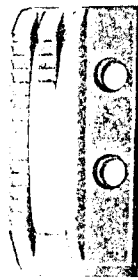
230625



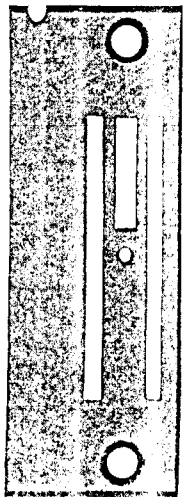
203173



203417



202818



202811



202828

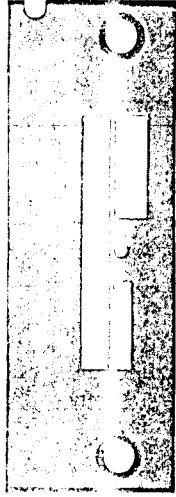


PLATE 13355 -FULL SIZE

203198



203199



203200



202373



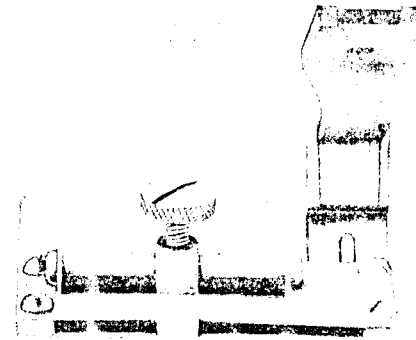
206787



26608



231238



From the library of Diamond Needle Corp

PLATE 13356-FULL SIZE

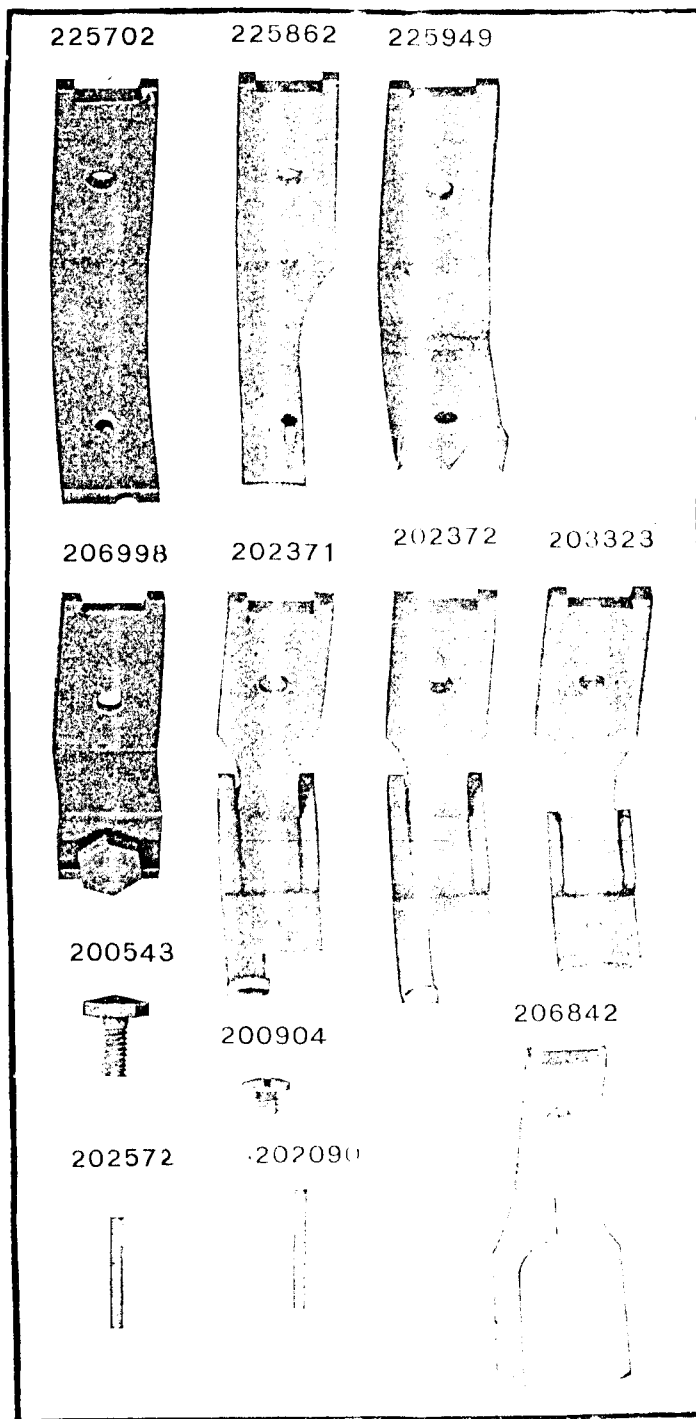


PLATE 13357-FULL SIZE

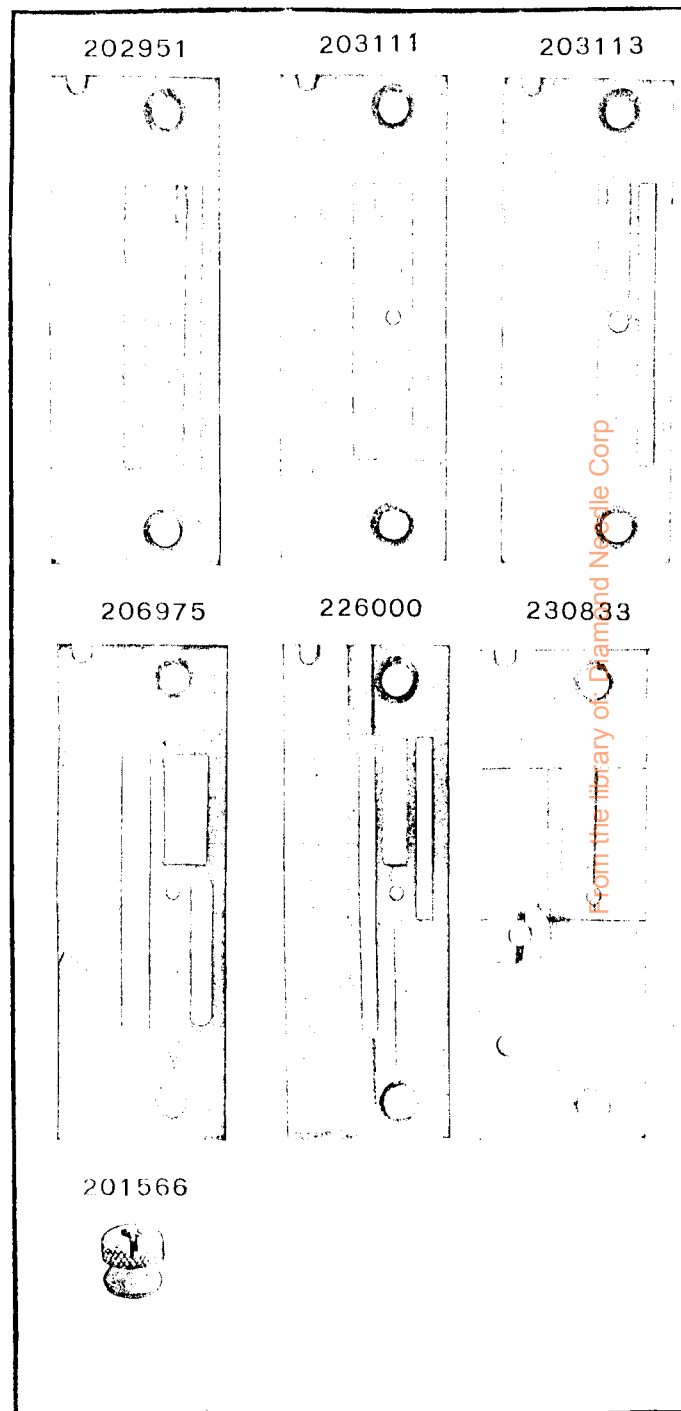
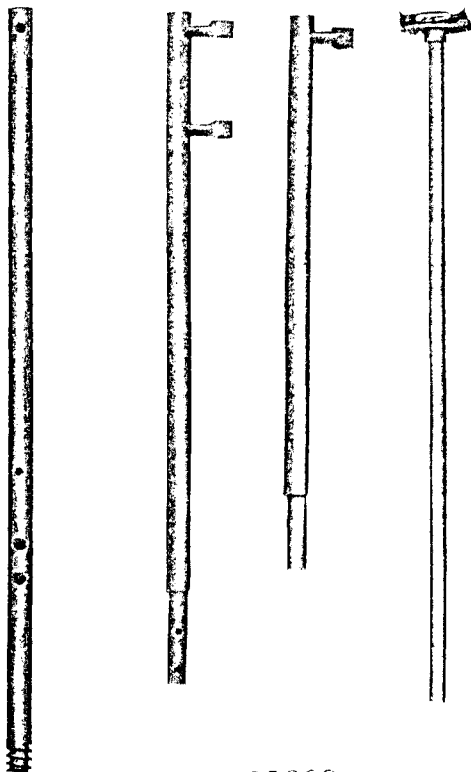
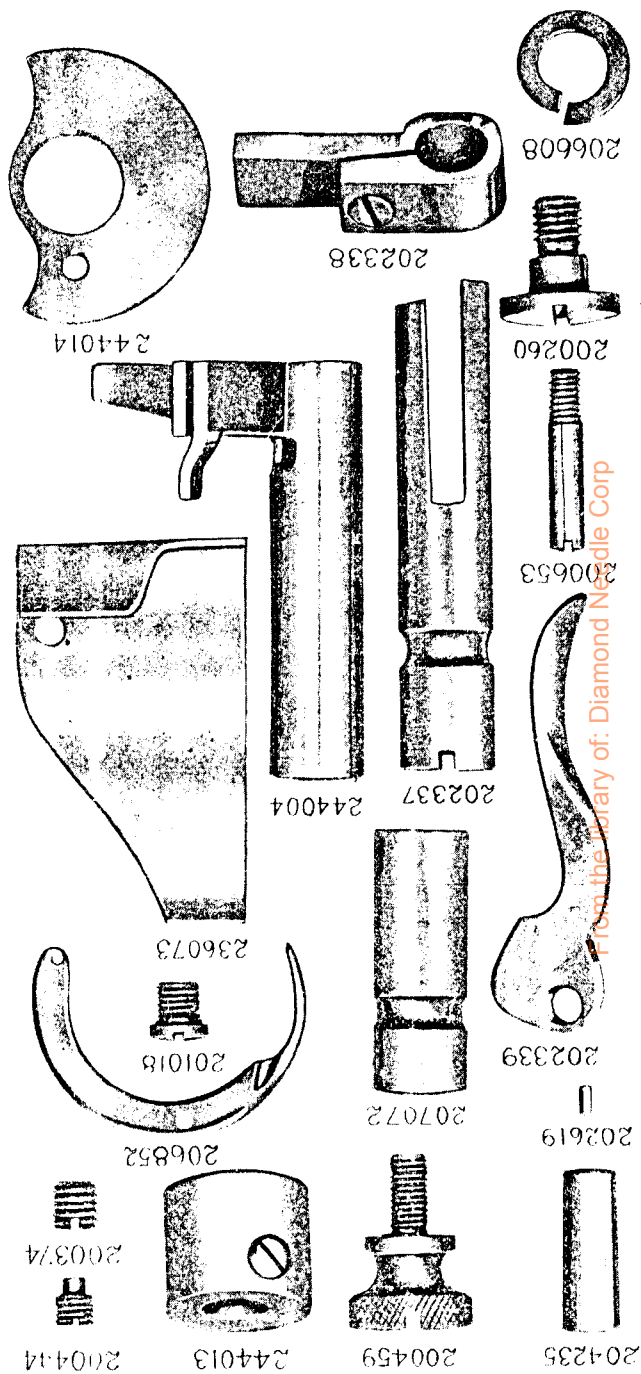
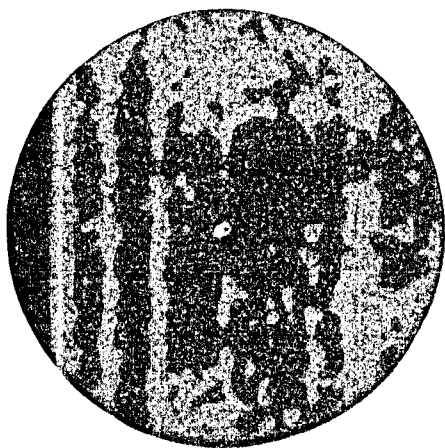


PLATE 13365-ONE-FOURTH SIZE

202250 202304 202654 206754



225663



204235 200459 244013 200414

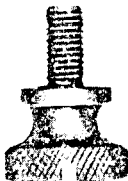
200374



206852



244013



200459

207072

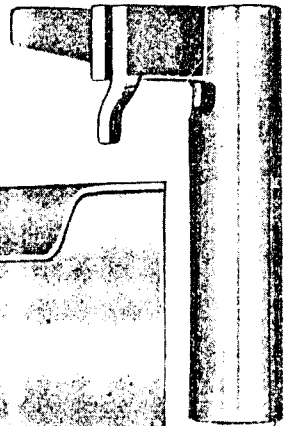


200459

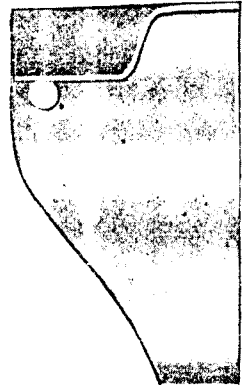
202337



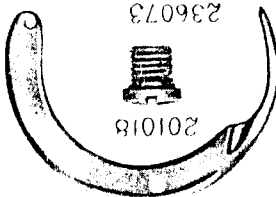
244004



244004



236073



201018

202619



204235

202339



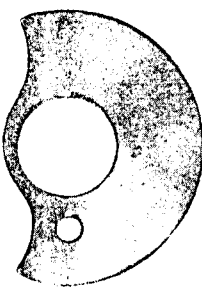
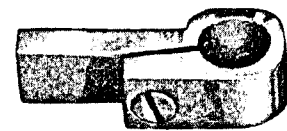
200653



200260



202338



244014

206608



PLATE 13875-FULL SIZE

From the Library of: Diamond Needle Corp

PLATE 13376-ONE-HALF SIZE

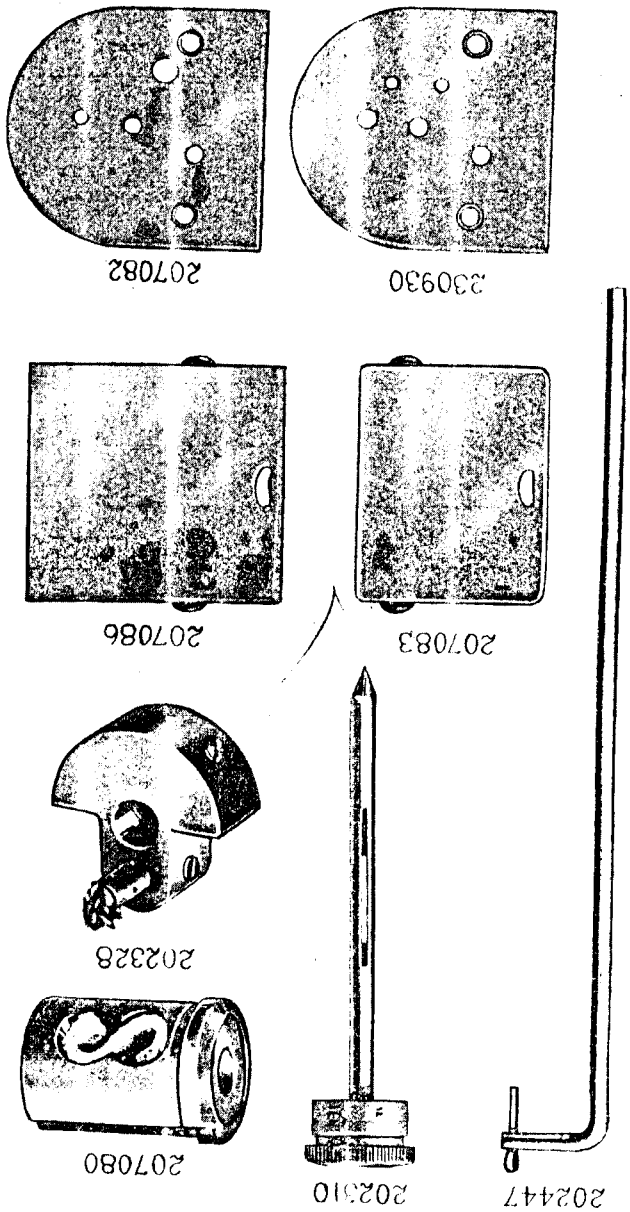


PLATE 13377-ONE-FOURTH SIZE

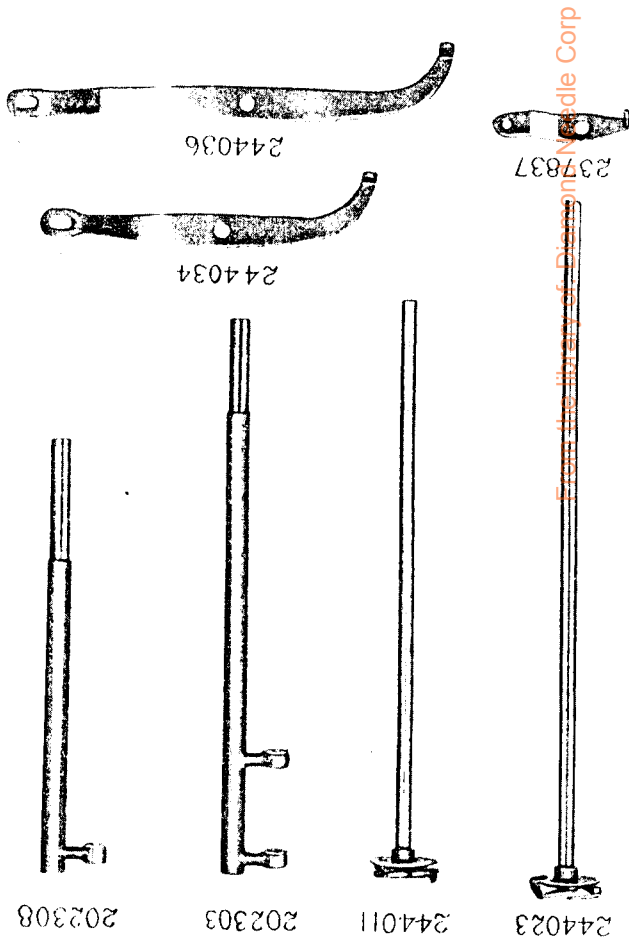


PLATE 13878-FULL SIZE

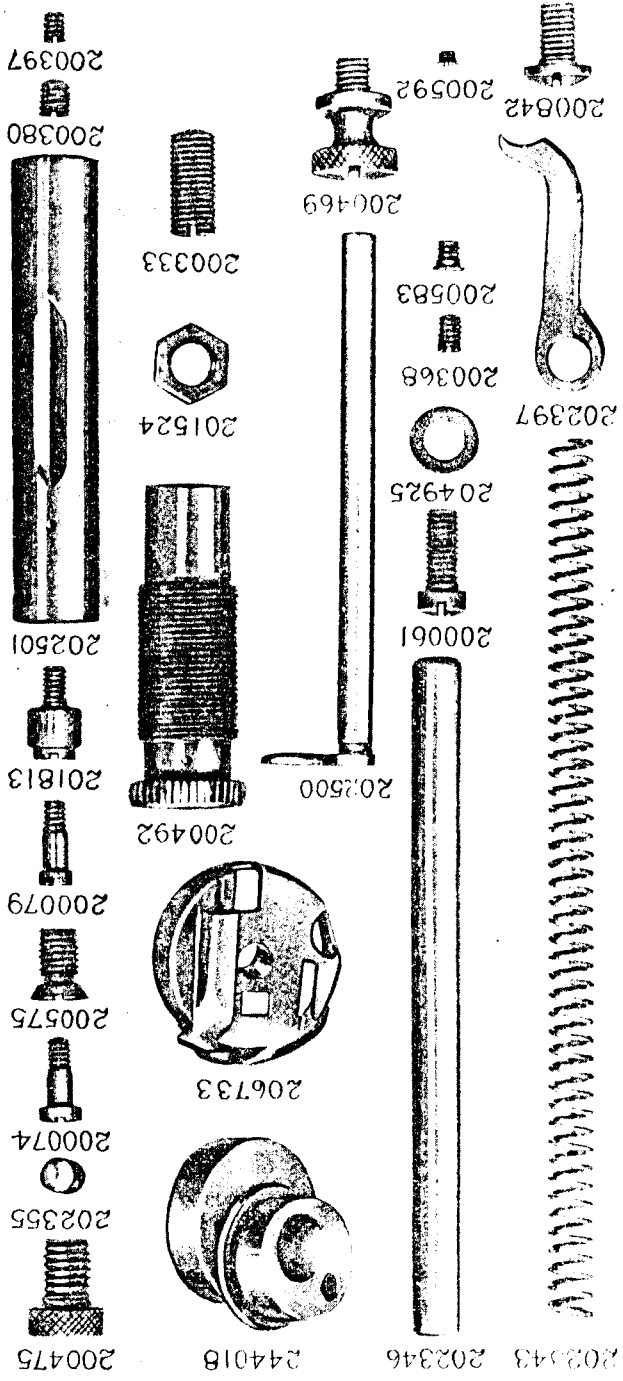
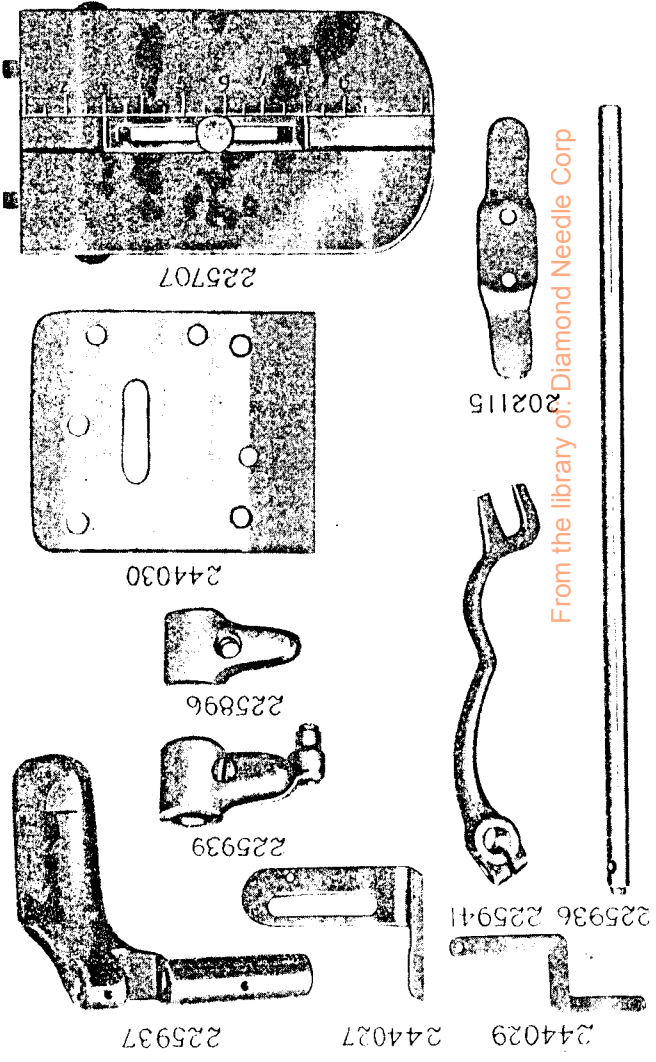


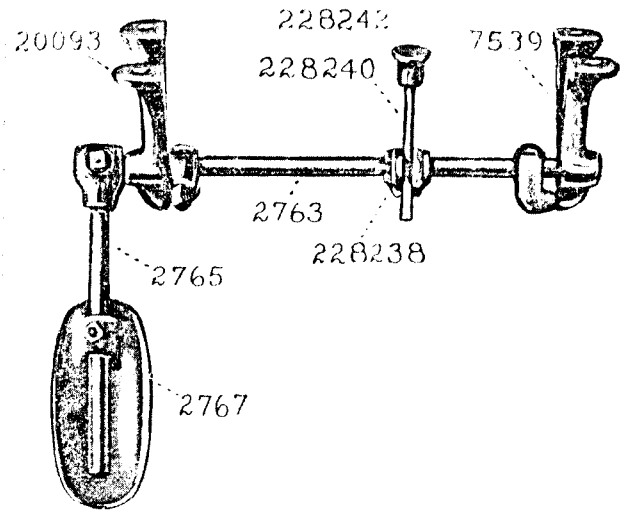
PLATE 13879-ONE-HALF SIZE



From the library of: Diamond Needle Corp



PLATE 14171—ONE-FOURTH SIZE



FULL SIZE

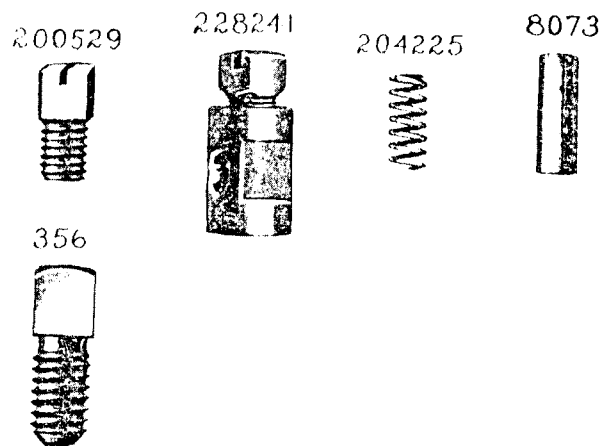
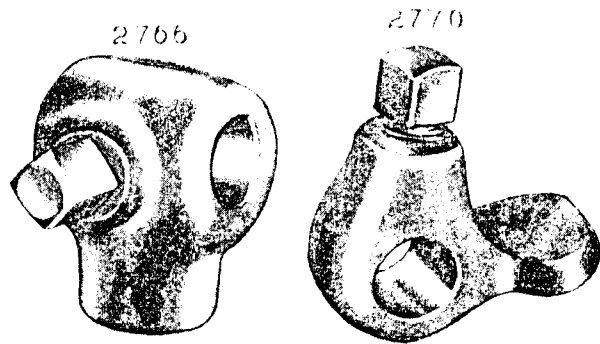
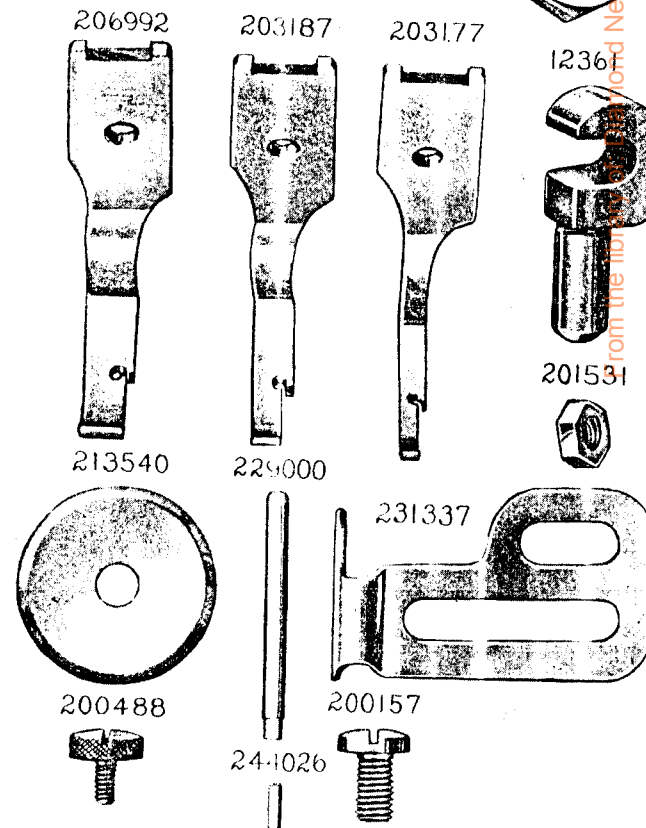
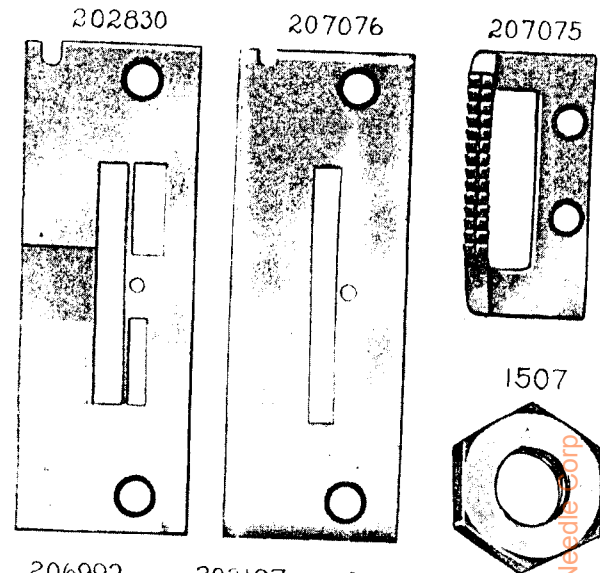
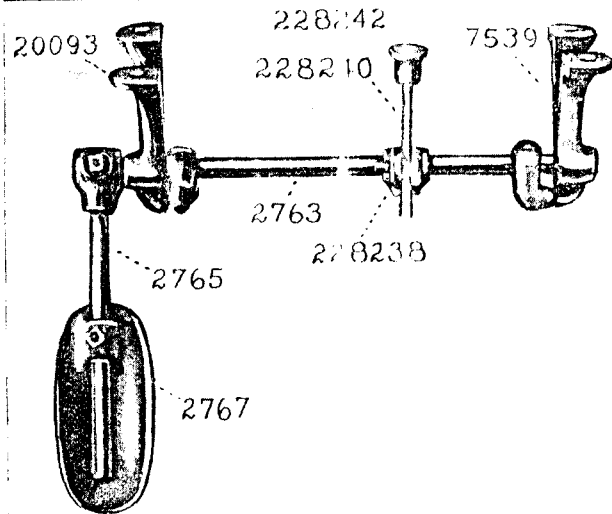


PLATE 13380—FULL SIZE



from the file for Word Needle Corp

PLATE 14171—ONE-FOURTH SIZE



FULL SIZE

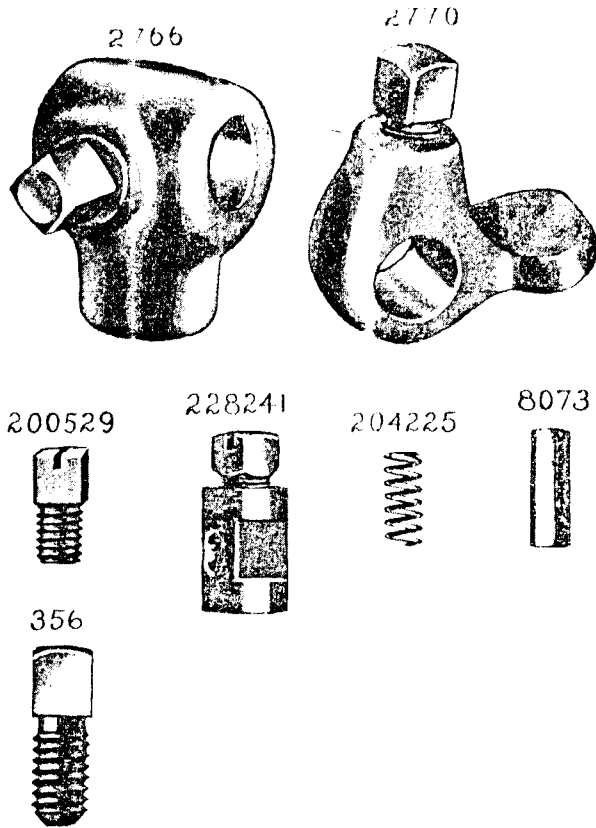


PLATE 14650—FULL SIZE

